

# A7 MIG gun

500-g

## CONTENTS

1.	The A7 MIG Gun 500-g .....	3
2.	Preface .....	3
3.	Identification.....	4
4.	CE marking .....	4
5.	Safety .....	4
5.1	Designated use.....	4
5.2	Responsibilities of the user .....	4
5.3	Personal protective equipment.....	4
5.4	Signs used in the documentation.....	5
5.5	Warning and notice signs .....	5
5.6	Emergency instructions .....	5
5.7	Operation safety.....	5
5.8	Product safety.....	6
6.	Technical data .....	7
6.1	General data .....	7
6.2	Product-specific data .....	7
6.3	Abbreviations .....	7
6.4	The type plate.....	7
7.	Delivery scope.....	8
8.	Transport.....	8
9.	Storage.....	8
10.	Functional description.....	9
10.1	The neck .....	9
10.2	The connection module .....	9
10.3	The mount .....	9
10.4	The hose assembly .....	9
11.	Installing the robot gun.....	10
11.1	Assembling the A7 MIG Gun 500-g neck.....	10
11.2	Connecting the hose assembly to the gun .....	11
11.3	Mounting the wire feeder side connection.....	11
11.4	Connecting the control line.....	12
11.5	Setting the shielding gas quantity .....	12
11.6	Introducing the wire .....	12
12.	Operation.....	13
12.1	The welding process .....	13
12.2	Completing the welding process.....	13
12.3	Maintenance and cleaning .....	14
12.3.1	Cleaning the wire guide.....	14
12.3.2	Shortening the wire liner .....	15
12.3.3	Cleaning the gun neck.....	15
13.	Troubleshooting.....	16
14.	Unmounting.....	17
14.1	Disposal .....	17
14.2	Materials .....	17
14.3	Consumables.....	17
14.4	Packaging .....	17
15.	Product codes for ordering.....	18

## 1. THE A7 MIG GUN 500-G

This document provides product information for the Kemppi A7 MIG Gun 500-g.

Kemppi MIG/MAG guns for automatic welding are designed for demanding professional use. They are suitable for use in all MIG units equipped with Kemppi robotic MIG wire feeders and power sources

## 2. PREFACE

Congratulations on your purchase of this product. Used correctly, Kemppi products can significantly increase the productivity of your welding, and provide many years of economical service.

This operating manual contains important information on the use, maintenance, and safety of your Kemppi product. The technical specifications of the equipment can be found in the chapter "Technical data" and at the end of this manual.

Please read the manual carefully before using the equipment for the first time. For your own safety and that of your work environment, pay particular attention to the safety instructions in the manual.

For more information on Kemppi products, contact Kemppi Oy, consult an authorized Kemppi dealer, or visit the Kemppi Web site: [www.kemppi.com](http://www.kemppi.com).

The specifications presented in this manual are subject to change without prior notice.

### **Disclaimer**

While every effort has been made to ensure that the information contained in this guide is accurate and complete, no liability can be accepted for any errors or omissions. Kemppi reserves the right to change the specification of the product described, at any time, without advance notice. Do not copy, record, reproduce, or transmit the contents of this guide without prior permission from Kemppi.

### 3. IDENTIFICATION

The welding gun system Kemppi A7 MIG Gun 500-g is used in industry and in the trade for welding using inert gases (MIG) or active gases (MAG). This model is gas-cooled and can be used in all welding positions. These operating instructions describe only the welding gun system A7 MIG Gun 500-g. The welding gun system may only be operated as supplied or with authentic Kemppi spare parts.



Figure 1: Kemppi A7 MIG Gun 500-g

### 4. CE MARKING

This device fulfils the requirements of the following EU directives:

- The Machinery Directive, 2006/42/EC
- The EMC Directive, 2004/108/EC
- The RoHS Directive, 2011/65/EU

### 5. SAFETY

Read and follow the additional safety instructions enclosed.

#### 5.1 Designated use

The gas-cooled welding gun system A7 MIG Gun 500-g must be used for robot and automatic application as described in this manual. Designated use also includes complying with the prescribed operation, maintenance, and servicing conditions.

Any use other than that described under “Designated use” is considered contrary to the intended use.

Unauthorized conversions or power-increasing modifications are not allowed.

The warranty does not cover wear parts and damage due to overloading or improper use.

#### 5.2 Responsibilities of the user

- Keep the operating instructions within easy reach in the location of the device for reference, and include the operating instructions when handing over the product.
- Installation, operation, and maintenance work may only be carried out by qualified personnel. Qualified personnel are persons who, on account of their special training, knowledge, experience, and familiarity with the relevant standards, are able to assess the tasks assigned to them and identify possible dangers.
- Keep all other persons out of the work area.
- Follow the accident prevention regulations of the relevant country.

- Ensure good lighting of the work area, and keep the area clean.
- Observe the following standards and guidelines in particular:
  - 89/391/EEC: Directive on the introduction of measures to encourage improvements in the safety and health of workers at work
  - 2009/104/EC: Directive concerning the minimum safety and health requirements for the use of work equipment by workers at work
  - 2004/108/EC: Directive on the harmonization of the laws of the Member States relating to electromagnetic compatibility The occupational health and safety regulations of the country in question
  - Regulations on occupational safety and accident prevention

#### 5.3 Personal protective equipment

To avoid danger to the user, using personal protective equipment (PPE) is recommended in these instructions.

PPE consists of the following:

- Protective clothing
- Safety goggles
- A class-P3 respiratory mask
- Gloves
- Safety shoes

## 5.4 Signs used in the documentation

Items in the manual that require particular attention, to minimize damage and personal injury, are indicated with a three-level notification and warning system. Read these sections carefully, and follow the instructions.



 *Note: These items give the user a useful piece of information.*

 *Caution: A cautionary item describes a situation that may result in damage to the equipment or system.*

 *Warning: Warnings describe a potentially dangerous situation. If not avoided, it will result in personal harm or fatal injury.*

## 5.5 Warning and notice signs

The following warning and notice signs can be found on the product:

  *Read and observe the operating instructions!*

These markings must always be legible. They must not be covered, obscured, painted over, or removed.

## 5.6 Emergency instructions

In the event of an emergency, immediately interrupt the following:

- The power supply
- The flow of compressed air

Further measures are described in the operating instructions or in the documentation of other peripheral devices.

## 5.7 Operation safety

Please study these operation safety instructions and respect them when installing, operating, and servicing the machine.

### The welding arc and spatter

The welding arc harms unprotected eyes. Be careful also with reflecting flashes from the arc. The welding arc and spatter burn unprotected skin. Wear safety gloves and protective clothing.

### Danger of fire or explosion

Pay attention to fire safety regulations. Remove flammable or explosive materials from the welding location. Always reserve sufficient fire-fighting equipment at the welding location. Be prepared for hazards in special welding jobs – for example, the danger of fire or explosion in welding of container-type work pieces.

 *Fire can break out from sparks even several hours after the welding is completed!*

### Cables

Always check the cables before operating the equipment. Replace damaged cables without delay.

Damaged cables may cause injury or start a fire. Connection cables must not be compressed or make contact with sharp edges or hot work pieces.

### The welding power circuit

Isolate yourself by using proper protective clothing, and do not wear wet clothing. Never work on a wet surface or use damaged cables. Do not place the MIG gun or welding cables on the welding machine or on other electric equipment. Do not press the MIG gun's switch if the gun is not directed towards a work piece.

### Welding fumes

Make sure that there is sufficient ventilation during welding. Take special safety precautions when welding metals that contain lead, cadmium, zinc, mercury, or beryllium.

## 5.8 Product safety

### Hazards caused by improper use

If improperly used, the device can present risks to people and physical property.

- Use the device in accordance with its designated use only.
- Do not convert or modify the device to enhance its performance without appropriate authorization.

The device may only be used by qualified personnel.

- The product has been developed and manufactured in accordance with state-of-the-art technology and the recognized safety standards and regulations. These operation instructions warn you against unavoidable residual risks to users, third parties, devices, or other physical property. Disregarding these warnings may result in risks to human life and health, harm to the environment, or other physical damage.
- The product may only be operated in unmodified, technically perfect condition, within the limits described in these instructions.
- Always observe the limit values specified in the technical data. Overloads lead to destruction.
- Safety features of the device must never be disassembled, bridged, or otherwise bypassed.
- During welding work outdoors, use suitable protection against the weather conditions.
- Check the electrical device for any damage and for proper functioning in accordance with its designated use.
- Never expose the electrical device to rain, and avoid damp or wet environments.
- Protect yourself from electrical accidents by using insulating mats and wearing dry clothing.
- Never use the electrical device in areas subject to a risk of fire or explosion.
- Arc welding may cause damage to the eyes, skin, and hearing. When working with the device, always use the prescribed protective equipment.
- Metal vapors, especially from lead, cadmium, copper, and beryllium, are all hazardous to the health! Ensure that sufficient ventilation or extraction systems are in use. Always ensure compliance with the legal limit values.

- Using clean water, rinse work pieces that have been degreased with chlorinated solvents, to prevent the risk of phosgene gas forming. Do not place degreasing baths containing chlorine in the vicinity of the welding area.
- Adhere to the general fire protection regulations, and remove flammable materials from the vicinity of the welding work area before starting work.
- Keep suitable fire-extinguishing equipment ready for use in the work location.

## 6. TECHNICAL DATA

This chapter provides the technical data of the gun.

### 6.1 General data

The table below provides general torch data in line with EN 60 974-7.

Type of voltage	DC
Polarity of the electrodes	Usually positive
Wire types	Commercially available round wires
Type of use	Automatic
Voltage rating	Peak value of 141 V
Protection type of the machine side connections	IP3X (EN 60 529)
Shielding gas (DIN EN 439)	CO <sub>2</sub> and mixed gas M21

### 6.2 Product-specific data

This table provides product-specific torch data as laid out in EN 60974-7.\*

Type	Type of cooling	Load		ED	Wire Ø	Gas flow	Weight
		CO <sub>2</sub>	M21				
A7 MIG G		(A)	(A)	(%)	(mm)	(l/min)	
500-g	gas	500	400	100	0.8–1.6	10–30	900

\* For pulse-arc operation, the load figures are reduced by up to 35%.

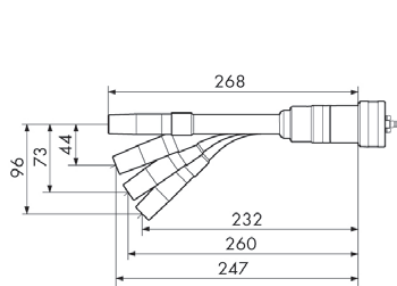

Figure 2: Gun neck lengths

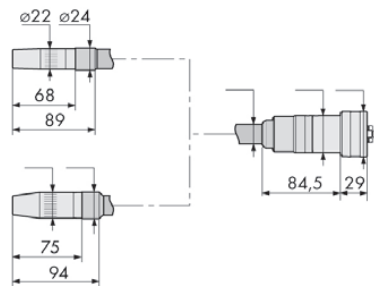

Figure 3: Gun neck diameters

### 6.3 Abbreviations

DC	Direct current
ED	Duty cycle
MIG	Metal inert gas
MAG	Metal active gas
MAC value	Maximum allowable concentration of harmful substances in the work location
Voltage rating	Insulation resistance, electric strength, and protection class
TCP	Tool center point

### 6.4 The type plate

The Kemppi A7 MIG Gun welding gun system is identified by a sticker or a Kemppi logo. When contacting our service staff, please remember to check the production stamp located near the Kemppi logo on the gun neck.

## 7. DELIVERY SCOPE

The standard scope of delivery for the hose assembly includes the following components:

- Kink protection on the torch neck side with an integrated switch cover
- Kink protection on the machine side with a central plug
- Operating instructions

For the initial assembly, the following components are required, depending on the welding task at hand.

- Gun neck (in the preferred size and geometry)
- Cable assembly (length depends on robot type)

To be ordered separately

- Gun mount (required for attachment to the robot)
- Set-up parts and wear parts (ordered separately)

Order data and part numbers can be found in the current Kemppi spare-parts and wear-parts list. The contact information for consulting and ordering can be found on the Internet, at [www.kemppi.com](http://www.kemppi.com).

## 8. TRANSPORT

The components are carefully checked and packed; however, damage may still occur during shipping.

<i>Checking procedure on receipt of goods</i>	Check that the shipment is correct by referring to the shipping note.
<i>In case of damage</i>	Check the package and components for damage (perform a visual inspection).
<i>In the event of problems</i>	If the goods have been damaged during transport, contact the last carrier immediately. Keep the packaging (for possible checks by the carrier).
<i>Packaging for return of the goods</i>	Use the original packaging and the original packaging materials. If you have questions about the packaging and safety during shipment, please consult your supplier.

## 9. STORAGE

The appropriate physical conditions for storage in a closed room are 25 °C to 55 °C.



## 10. FUNCTIONAL DESCRIPTION

The functioning welding gun system Kemppi A7 MIG Gun 500-g comprises the following components:

Figure 4: Welding gun system A7 MIG Gun 500-g

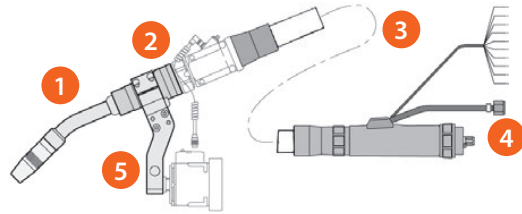

1. Gun neck
2. Connection module
3. Cable hose assembly
4. Central plug
5. Segment holder

**!** Risk of injury due to unexpected start-up

For the entire duration of maintenance, servicing, unmounting, and repair work, the following instructions must be adhered to:

- Switch off the power supply.
- Cut off the compressed air supply.
- Pull the power plug.

All elements together form an operating unit that provides a plasma arc for welding when supplied with the appropriate operation resources. The welding wire required for welding is fed through the welding gun system A7 MIG Gun 500-g all the way to the contact tip. The contact tip transmits the welding current to the welding wire, producing an arc between the welding wire and work piece. The light arc and the molten pool are protected by the inert gas (MIG) or active gas (MAG).

### 10.1 The neck

Standard A7 MIG Gun 500-g necks are available in the following geometries: straight, 22°, 35°, and 45° bends. Special designs will be manufactured upon request, depending on the application.

The uniform interface at the connecting module makes all torch necks compatible with one another.

### 10.2 The connection module

The connection module establishes the connection between the welding torch and the hose assembly.

### 10.3 The mount

The mount is used to attach the welding gun system to the robot via the Kemppi robot mount.

### 10.4 The hose assembly

The gas-cooled hose assembly provides the welding torch with all components required for welding, such as welding current, shielding gas, and air.

## 11. INSTALLING THE ROBOT GUN

**!** Risk of injury due to unexpected start-up

For the entire duration of maintenance, servicing, unmounting, and repair work, the following instructions must be adhered to:

- Switch off the power supply.
- Cut off the compressed air supply.
- Pull the power plug.

**i** Read the safety instructions in this manual and the separate safety instructions.

The system may only be installed by authorized personnel.

### 11.1 Assembling the A7 MIG Gun 500-g neck

This section describes how to assemble the A7 MIG Gun 500-g neck.

Figure 5: A7 MIG Gun 500-g neck assembly

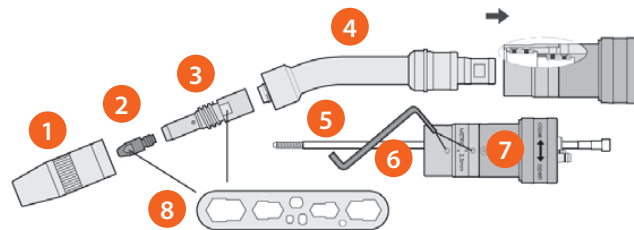

1. Gas nozzle
2. Contact tip
3. Contact tip holder
4. Gun neck
5. Neck liner connection module
6. Allen key
7. Adjustable wrench

#### Proceed as follows:

1. Screw the replaceable tip adapter (3) into the torch neck (4), and tighten it, using an adjustable wrench (8).
2. Screw the contact tip (2) into the tip adapter (3), and tighten it with the adjustable wrench (8).
3. Screw the gas nozzle (1) onto the tip adapter (3) by hand.
4. Insert the torch neck (4) all the way into the connecting module (6).
5. Tighten the hexagonal-head screws by using the Allen key (7).
6. Insert the neck liner (5) on the connection side through the connecting module (6) into the torch neck (4).

## 11.2 Connecting the hose assembly to the gun

This section describes how to assemble the A7 MIG Gun 500-g neck.

Figure 6: Connecting the hose assembly to the gun

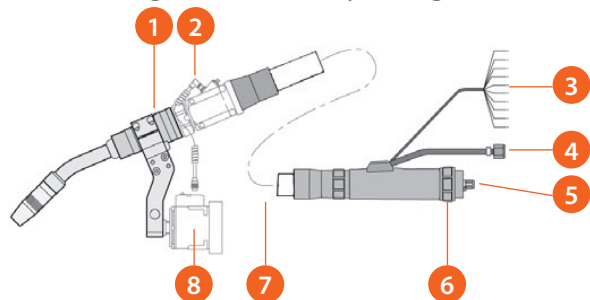

1. Connection module
2. EMERGENCY STOP cable
3. Control line
4. Air-blast hose
5. Central plug connection
6. Hose assembly
7. Robot mount

### Proceed as follows:

8. Select the proper wire type and the corresponding wire guide. See Section 12.3 for details on cutting the wire to size and on correct mounting.
  - Wire liners for steel and stainless steels
  - PA liners for aluminum, copper, nickel, and stainless steels
5. Joining the hose assembly with the gun
9. Lay the hose assembly (7) straight, and attach it to the connection module (1) on the gun neck side.
10. Slide the ready-to-use wire guide from the central plug (5) up to the stop in the changeable body, and screw it down by using the connection nut (6).

If required, connect the EMERGENCY STOP cable (2) of the robot mount (8) to the hose assembly (7). See Section 11.4.

## 11.3 Mounting the wire feeder side connection

This section describes how to mount the wire feeder side connection. See Section 11.2.

### Proceed as follows:

1. Check that the wire guide has been fastened in place correctly.
2. Join the central plug (5) and the central socket at the wire feed unit, and secure them with a connection nut (6).
3. Fasten the air-blast hose (4) to the air-blast and spraying unit or the air-blast valve. Seal the connection gas-tight if the "Cleaning with compressed air" option will not be in use.

## 11.4 Connecting the control line

The control line is normally delivered with a pre-soldered amphenol plug, which is compatible with the Kemppi wire feeder. Otherwise, choose a compatible plug for your wire feeder and solder it to the corresponding wires in accordance with the assignment plan.

Figure 7: Connecting the control line

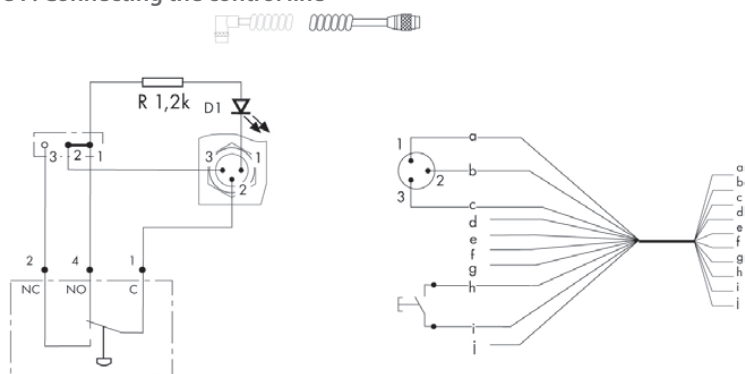

The color codes are:

- a = green
- b = white
- c = brown
- d = yellow (insulated)
- e = gray (insulated)
- f = blue (insulated)
- g = pink (insulated)
- h = black
- i = purple
- j = red (insulated)

## 11.5 Setting the shielding gas quantity

This section describes how to set the shielding gas quantity.

**i** The type and quantity of the shielding gas depend on the welding task and the gas nozzle geometry.

To prevent the shielding gas supply from becoming clogged by impurities, the cylinder valve must be opened briefly, before connection of the cylinder. This will blow out any impurities that may be present.

Make all shielding gas connections gas-tight.

**Proceed as follows:**

1. Connect the shielding gas cylinder to the wire feeding system.
2. Set the gas quantity on the pressure reducer of the shielding gas cylinder.

## 11.6 Introducing the wire

This section describes how to introduce the wire.

**i** Each time you change the wire, make sure that the beginning of the wire is burr-free.

**Proceed as follows:**

1. Insert the wire in the wire feed unit as specified by the manufacturer.
2. Press the "Current-less wire feed" button at the wire feed unit.

## 12. OPERATION

 *Shortness of breath and poisoning caused by inhaling phosgene gas*

Phosgene gas is formed during the welding of work pieces that have been degreased with chlorine-containing solvents.

Do not inhale fumes and vapors.

Ensure a sufficient supply of fresh air.

Rinse the work pieces with clear water prior to welding.

Do not place degreasing baths containing chlorine in the vicinity of the welding area.

### **Risk of burns**

During welding work that sprays sparks, glowing work pieces or hot slag can produce flames.

Check the work area for seats of fire.

Make suitable fire-extinguishing materials available in the work location.

Allow the work pieces to cool down after welding.

Before performing welding work, fasten the ground clamp properly to the work piece or the welding table.

### **Dazzling of the eyes**

The arc produced by welding may damage the eyes.

Wear suitable protective clothing and eye protection.

 *The welding torch may only be operated by qualified personnel.*

Ensure that all required parameters, such as the welding current and wire feed, have been set at the welding power supply in accordance with your welding task.

## 12.1 The welding process

This section describes the welding process.

### **Proceed as follows:**

1. Open the shielding gas cylinder.
2. Switch on the power supply.

## 12.2 Completing the welding process

This section describes how to quit when the welding process has been done.

### **Proceed as follows:**

1. Wait until the shielding gas flow has subsided.
2. Close the shut off valve for the gas supply.
3. Switch off the power supply.

## 12.3 Maintenance and cleaning

Scheduled maintenance and cleaning are prerequisites for a long service life and trouble-free operation.

Once a month, thoroughly clean the robot mount to remove all dirt and welding spatter.

 *Risk of injury due to unexpected start-up*

For the entire duration of maintenance, servicing, unmounting, and repair work, the following instructions must be adhered to:

- Switch off the power supply.
- Cut off the compressed air supply.
- Pull the power plug.

 *Electric shock*

Dangerous voltages can be produced because of defective cables.

- Check all live cables and connections for proper installation.
- Replace any parts that have suffered damage, deformation, or wear.

 *The maintenance intervals listed are recommended values and assume single-shift operation.*

- Maintenance and cleaning work may only be carried out by qualified and trained specialists.
- Always wear your personal protective clothing when performing maintenance and cleaning work.
- Remove adhering welding spatter.
- Check all screw joints for a tight fit.
- The maintenance intervals listed are recommended values and assume single-shift operation.

### 12.3.1 Cleaning the wire guide

This section describes how to clean the wire guide.

 *Risk of injury*

Serious injuries can be caused by parts articulating rapidly.

When cleaning the wire guide with compressed air, wear suitable protective clothing – in particular, safety goggles.

#### **Proceed as follows:**

1. Unscrew the hose assembly from the machine side, and lay it straight.
2. Unscrew the retaining nut, and pull out the wire liner or PA liner.
3. Clean the wire feed hose from both sides with compressed air.
4. Slide the adjusted wire liner or PA liner into the wire feed hose, and secure with a retaining nut.

### 12.3.2 Shortening the wire liner

This section describes how to shorten the wire liner.

**i** *Unused wire liners or PA liners have to be shortened to the actual length of the hose assembly.*

Mounting of plastic liners is similar to mounting of wire liners. Refer to the operating instructions of the manufacturer of the wire feeder.

Plastic liners are used for aluminum. Plastic liners and fastening material are available on request.

Figure 8: Shortening the wire liner

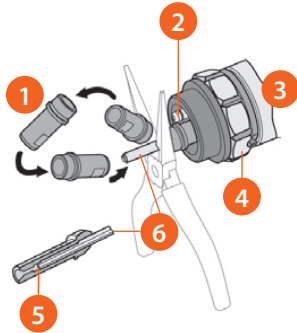

1. Support sleeve
2. Central plug
3. Hose assembly
4. Retaining nut
5. Collet chuck
6. Liner

#### Proceed as follows:

1. Lay out the hose assembly (3) straight.
2. Disconnect the central plug (2) from the feed unit.
3. Remove the old liner (6), and replace it with a new one. Then insert the non-insulated side into the central plug (2) as far as it will go.
4. Place the support sleeve (1), turned 180°, on the new spiral liner (6) (on the side without the liner).
5. Cut off the protruding wire liner (6). The liner must be even with the support sleeve (1).
6. Screw the collet chuck (4) onto the spiral liner (6) as far as it will go.  
The position of the wire guide can be checked through the sight hole of the collet chuck (5).
7. Slide the collet chuck (5) and the wire liner (6) into the central plug (2) as far as they will go.
8. Slide the support sleeve (1), with the thread side first, into the central plug (2), and tighten it.
9. Attach the hose assembly (3) to the central plug (2), using the retaining nut (4).

### 12.3.3 Cleaning the gun neck

This section describes how to clean the gun neck.

To increase the availability time of the welding robot, Kemppi offers an option for automated gun cleaning.

#### Proceed as follows:

1. Remove the gas nozzle.
2. Remove welding spatter, and spray the gas nozzle with a suitable anti-spatter agent.
3. Check the wear parts for visible damage, and replace any damaged parts if doing so is required.
4. Replace the equipment kit if it is worn or dirty.
5. Clean the separating point and O-rings with a silicone-free sealing grease.
6. Check the TCP after each use and after any collisions. Use, for example, an alignment jig to do this.

## 13. TROUBLESHOOTING

 Risk of injury due to unexpected start-up

For the entire duration of maintenance, servicing, unmounting, and repair work, the following instructions must be adhered to:

- Switch off the power supply.
- Cut off the compressed air supply.
- Pull the power plug.

In the event of any doubts or problems, please contact your retailer or the manufacturer.

 Please also consult the operating instructions for the other welding components, such as the power supply and air pressure line.

<i>Problem</i>	<i>Cause</i>	<i>Solution</i>
Gun neck gets hot	Contact tip not tightened	Check and tighten
	Contact tip loose on the neck side.	Check and tighten, and direct toward the work piece
No push-button function	Control line interrupted or defective	Check/repair
Wire burned solid in the contact tip	Wrong parameters set	Check or correct the setting(s)
	Contact tip worn out	Replace
Irregular wire feed	Guide spiral liner / PA liner clogged	Clean in both directions with compressed air, or replace the liner if necessary
	Contact tip and wire diameter not correctly matched	Replace contact tip
	Wrong contact pressure set at the wire feed unit	Correct as specified by manufacturer
Arc between gas nozzle and work piece	Spatter bridge between contact tip and gas nozzle	Clean and spray gas nozzle interior
Unstable arc	Contact tip not matched to the wire diameter, or increase in contact tip diameter	Check contact tip
	Wrong welding parameters set	Correct welding parameters
	Wire guide unit worn out	Replace wire guide unit
Pore formation	Strong spattering in the gas nozzle	Clean gas nozzle
	Insufficient or missing gas cover	Check gas cylinder contents and pressure setting
	Air currents blow shielding gas away	Shield welding area with partitions



## 14. UNMOUNTING

This section describes how to unmount the welding gun.

Unmounting may only be carried out by specialist personnel. Please make sure that the shutdown procedures are strictly observed before the unmounting work begins. Ensure this also for the components integrated into the welding system.

 *Risk of injury due to unexpected start-up*

For the entire duration of maintenance, servicing, unmounting, and repair work, the following instructions must be adhered to:

- Switch off the power supply.
- Cut off the compressed air supply.
- Pull the power plug.

For the entire duration of maintenance, servicing, unmounting, and repair work, the following instructions must be adhered to:

- Switch off the power supply.
- Cut off the compressed air supply.
- Switch off the entire welding system.
- Pull the power plug.

 *See also Section 12.2.*

Proceed as follows:

1. Disconnect the hose assembly from the wire feed.
2. Remove the parts to be disconnected (changeable body, mount, robot mount, and gun neck).

### 14.1 Disposal

For disposal, the locally applicable regulations, laws, provisions, standards, and guidelines must be observed. For the welding torch system to be properly disposed of, it must be unmounted first.

### 14.2 Materials

This product consists for the most part of plastics, steel, and non-ferrous metals. Steel and non-ferrous metals can be melted down, so iron materials are almost infinitely recyclable. The plastic materials used are marked in preparation for appropriate sorting of the materials for later recycling.

### 14.3 Consumables

Oils, greases, and cleaning agents must not contaminate the ground or enter the sewer system. These materials must be stored, transported, and disposed of in suitable containers. Please observe the relevant local regulations and the disposal instructions on the safety data sheets supplied by the manufacturer of the consumables. Contaminated cleaning tools (brushes, rags, etc.) must also be disposed of in accordance with the information provided by the manufacturer of the consumables

### 14.4 Packaging

The shipping packaging has been reduced to a minimum. Packaging materials are always selected with attention to their recyclability.

## 15. PRODUCT CODES FOR ORDERING

<i>Gun neck</i>	<i>Product code</i>
Gun neck A7 MIG 500-g 0° *	SP600621
Gun neck A7 MIG 500-g 22°	SP600622
Gun neck A7 MIG 500-g 35°	SP600623
Gun neck A7 MIG 500-g 45°	SP600624

<i>Robot gun mount</i>	<i>Product code</i>
Robot Gun Mount T3 G – without collision detector	SP600575
Robot Gun Mount T1 G	SP600589
Robot Gun Mount T2 L	SP600605
Segment holder for T2 robot gun mount	SP600608
Robot Gun Mount T4 – without collision detector	SP600604

\* For the correct cable length, inform Kemppi of the robot type, the robot manufacturer, the robot gun mount and the wire feeder connector.

### Consumable parts for A7 MIG guns

<i>Item</i>	<i>Type</i>		<i>Product code</i>
Contact tip holder	CONTACT TIP ADAPTER M8 G500 (copper)		SP600629
Contact tip Life +	Wire Ø	Hole Ø	
	0.8	0.9	W007919
	0.9	1.05	W007920
	1.0	1.15	W006826
	1.2	1.6	W006518
Gas nozzle	1.4	1.8	W007921
	Gas nozzle, bottle form, NW 16/+3		SP600626
	Gas nozzle, bottle form, NW 16/0		SP600643
	Gas nozzle, bottle form, NW 16/-2		SP600644
	Gas nozzle, conical, NW 16/+3		SP600645
Neck liner	(For wire brake module) Neck liner, steel 1.0-1.2		SP600564
	Liner (wire brake module)	Liner chili 2.0/4.7, 2.5 m, ROBOT EU	SP600665
		Liner chili 2.0/4.7, 2.5 m, ROBOT PP	SP600667
Liner	Liner chili HP 2.0/4.7, 2.5 m, ROBOT EU		SP600666
	Liner chili HP 2.0/4.7, 2.5 m, ROBOT PP		SP600668
	PP = Power pin HP = Heat protection EU = Euro connection		

