

EN

1920650
R03

OPERATING MANUAL

Robot Gun Mount

T3

CONTENTS

1.	Robot Gun Mount T3.....	3
2.	Preface	3
3.	Identification.....	4
4.	CE marking	4
5.	Safety	4
5.1	Designated use.....	4
5.2	Responsibilities of the user	4
5.3	Personal protective equipment.....	4
5.4	Signs used in the documentation.....	5
5.5	Warning and notice signs	5
5.6	Emergency instructions	5
5.7	Operation safety.....	5
5.8	Product safety.....	6
6.	Technical data	7
6.1	Ambient conditions	7
6.2	Weight	7
6.3	General data	7
6.4	Product-specific gun data	7
6.5	Abbreviations	8
6.6	The type plate.....	8
7.	Delivery scope.....	8
8.	Transport.....	8
9.	Storage.....	9
10.	Functional description.....	9
11.	Installing Robot Gun Mount T3	10
11.1	Fastening Robot Gun Mount T3 to the robot.....	10
11.2	The maintenance position of the robot	11
11.3	Mounting the hose assembly on the robot.....	12
11.4	Attaching the A7 MIG G gun neck.....	13
11.5	Attaching the A7 MIG W gun neck	13
11.6	Mounting the wire liner	14
12.	Operation.....	15
13.	Unmounting.....	15
14.	Maintenance and cleaning	15
14.1	Cleaning robot mount T3 with A7 MIG Gun 500-g	16
14.2	Cleaning robot mount T3 with A7 MIG Gun 500-w.....	16
14.3	Cleaning the wire liner.....	17
15.	Troubleshooting.....	18
16.	Removing the mount.....	19
16.1	Disposal	19
16.2	Materials	19
16.3	Consumables.....	19
16.4	Packaging	19
17.	Codes for ordering	20

1. ROBOT GUN MOUNT T3

This document provides product information for the Kemppi Robot Gun Mount T3 unit.

2. PREFACE

Congratulations on your purchase of this product. Used correctly, Kemppi products can significantly increase the productivity of your welding and provide many years of economical service.

This operating manual contains important information on the use, maintenance, and safety of your Kemppi product. The technical specifications of the equipment can be found in the chapter "Technical data" and at the end of this manual.

Please read the manual carefully before using the equipment for the first time. For your own safety and that of your work environment, pay particular attention to the safety instructions in the manual.

For more information on Kemppi products, contact Kemppi Oy, consult an authorized Kemppi dealer, or visit the Kemppi Web site: www.kemppi.com.

The specifications presented in this manual are subject to change without prior notice.

Disclaimer

While every effort has been made to ensure that the information contained in this guide is accurate and complete, no liability can be accepted for any errors or omissions. Kemppi reserves the right to change the specification of the product described, at any time, without prior notice. Do not copy, record, reproduce, or transmit the contents of this guide without prior permission from Kemppi.

3. IDENTIFICATION

Kemppi Robot Gun Mount T3 is used in industry and in the trade for connecting the gun neck to a robot equipped with central media guidance. It is available for gas-cooled guns (A7 MIG Gun 500-g) and liquid-cooled guns (A7 MIG Gun 500-w) by means of different adapter flanges. These instructions describe Kemppi Robot Gun Mount T3 only. This Kemppi robot mount must be operated only as supplied or equipped with authentic Kemppi spare parts.

Figure 1: Kemppi Robot Gun Mount T3

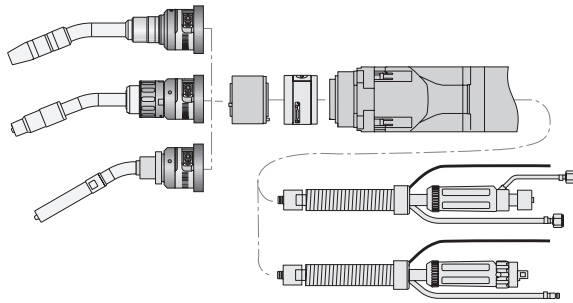

4. CE MARKING

This device fulfils the requirements of the following EU directives:

- The Machinery Directive, 2006/42/EC
- The EMC Directive, 2004/108/EC
- The RoHS Directive, 2011/65/EU

5. SAFETY

Read and follow the additional safety instructions enclosed.

5.1 Designated use

Robot Gun Mount T3 may be used only for the purpose described in these instructions, in the manner described. Follow the operation, maintenance, and servicing conditions whenever using the device.

Any other use is considered contrary to the intended use.

Unauthorized conversions or power-increasing modifications are not allowed.

The warranty does not cover wear parts and damage due to overloading or improper use.

5.2 Responsibilities of the user

- Keep the operating instructions within easy reach in the location of the device for reference, and include the operating instructions when handing over the product.
- Installation, operation, and maintenance work may only be carried out by qualified personnel. Qualified personnel are persons who, on account of their special training, knowledge, experience, and familiarity with the relevant standards, are able to assess the tasks assigned to them and identify possible dangers.
- Keep all other people out of the work area.
- Follow the accident prevention regulations of the relevant country.
- Ensure good lighting of the work area, and keep it clean.

- Observe the following standards and guidelines in particular:
 - 89/391/EEC: Directive on the introduction of measures to encourage improvements in the safety and health of workers at work
 - 2009/104/EC: Directive concerning the minimum safety and health requirements for the use of work equipment by workers at work
 - 2004/108/EC: Directive on the harmonization of the laws of the Member States relating to electromagnetic compatibility
 - The occupational health and safety regulations of the country in question
 - Regulations on occupational safety and accident prevention

5.3 Personal protective equipment

To avoid danger to the user, using personal protective equipment (PPE) is recommended in these instructions.

PPE consists of the following:

- Protective clothing
- Safety goggles
- A class-P3 respiratory mask
- Gloves
- Safety shoes

5.4 Signs used in the documentation

Items in the manual that require particular attention, to minimize damage and personal injury, are indicated with a three-level notification and warning system. Read these sections carefully, and follow the instructions.

 *Note: These items give the user a useful piece of information.*

 *Caution: A cautionary item describes a situation that may result in damage to the equipment or system.*

 *Warning: Warnings describe a potentially dangerous situation. If not avoided, it will result in personal harm or fatal injury.*

5.5 Warning and notice signs

The following warning and notice signs can be found on the product:

  *Read and observe the operating instructions!*

These markings must always be legible. They must not be covered, obscured, painted over, or removed.

5.6 Emergency instructions

In the event of an emergency, immediately interrupt the following:

- The power supply
- The flow of compressed air

Further measures are described in the operating instructions or in the documentation of other peripheral devices.

5.7 Operation safety

Please study these operation safety instructions and respect them when installing, operating, and servicing the machine.

The welding arc and spatter

The welding arc harms unprotected eyes. Also be careful with reflecting flashes from the arc. The welding arc and spatter burn unprotected skin. Wear safety gloves and protective clothing.

Danger of fire or explosion

Pay attention to fire safety regulations. Remove flammable or explosive materials from the welding location. Always reserve sufficient fire-fighting equipment at the welding location. Be prepared for hazards in special welding jobs – for example, the danger of fire or explosion in welding of container-type work pieces.

 *Fire can break out from sparks even several hours after the welding is done!*

Cables

Always check the cables before operating the equipment. Replace damaged cables without delay.

Damaged cables may cause injury or start a fire. Connection cables must not be compressed or come in contact with sharp edges or hot work pieces.

The welding power circuit

Isolate yourself by using proper protective clothing, and do not wear wet clothing. Never work on a wet surface or use damaged cables. Do not place the MIG gun or welding cables on the welding machine or on other electric equipment. Do not press the MIG gun's switch if the gun is not directed towards a work piece.

Welding fumes

Make sure that there is sufficient ventilation during welding. Take special safety precautions when welding metals that contain lead, cadmium, zinc, mercury, or beryllium.

5.8 Product safety

Hazards caused by improper use

If improperly used, the device can present risks to people and physical property.

- Use the device in line with its designated use only.
- Do not convert or modify the device to enhance its performance without appropriate authorization.

The device may only be used by qualified personnel.

- The product has been developed and manufactured in accordance with state-of-the-art technology and the recognized safety standards and regulations. These operating instructions warn you against unavoidable residual risks to users, third parties, devices, and other physical property. Disregarding these warnings may result in risks to human life and health, harm to the environment, or other physical damage.
- The product may only be operated in unmodified, technically perfect condition, within the limits described in these instructions.
- Always observe the limit values specified in the technical data. Overloads lead to destruction.
- Safety features of the device must never be disassembled, bridged, or otherwise bypassed.
- During welding work outdoors, use suitable protection against the weather conditions.
- Check the electrical device for any damage and for proper functioning in accordance with its designated use.
- Never expose the electrical device to rain, and avoid damp or wet environments.
- Protect yourself from electrical accidents by using insulating mats and wearing dry clothing.
- Never use the electrical device in areas subject to a risk of fire or explosion.
- Arc welding may cause damage to the eyes, skin, and hearing. When working with the device, always use the prescribed protective equipment.
- Metal vapors, especially from lead, cadmium, copper, and beryllium, are all hazardous to the health! Ensure the use of sufficient ventilation or extraction systems. Always ensure compliance with the legal limit values.

- Using clean water, rinse work pieces that have been degreased with chlorinated solvents, to prevent the risk of phosgene gas forming. Do not place degreasing baths containing chlorine in the vicinity of the welding area.
- Adhere to the general fire protection regulations, and remove flammable materials from the vicinity of the welding work area before starting work.
- Keep suitable fire-extinguishing equipment in the work area, ready for use.

6. TECHNICAL DATA

This chapter contains the technical data for the gun mount.

6.1 Ambient conditions

Table 1: Ambient conditions

Ambient temperature	25 °C to 55 °C
Transport and storage	-10 °C to 55 °C
Relative humidity	up to 70% at 20 °C

6.2 Weight

Dimensions	Ø = 73 mm	L = 109 mm
Weight, without gun	900 g	

6.3 General data

The table below presents general data in line with EN 60 974-7.

	A7 MIG Gun 500-g	A7 MIG Gun 500-w
Type of voltage	DC	
Polarity of the electrodes	Usually positive	
Wire types	Commercially available round welding wires	
Type of use	Automatic	
Voltage rating	Peak value of 141 V	
Protection class of the machine side connections	IP3X (EN 60 529)	
Shielding gas (DIN EN 439)	CO ₂ and M21	M21

6.4 Product-specific gun data

The following table applies to total Kemppi gun system, including gun neck, gun mount and cable assembly. This section provides product-specific gun data according to EN 60 974-7.

Type	Type of cooling	Load (A)		ED (%)	Wire Ø (mm)	Gas flow (l/min)
		CO ₂	M21			
500-g	gas	340	320	100	0.8–1.6	10–30
500-w	liquid	340	340	100	0.8–1.6	approx. 20

The cable assembly length is determined on the basis of the robot brand and model.

The load data have been determined under standard conditions, at low to medium reflected heat, with free air circulation and an ambient temperature of about 28 °C. In use under more rigorous conditions, the load values must be reduced by 10–20%. Applications with 340 A/100 % ED are possible with engineered solutions. Contact Kemppi sales.

6.5 Abbreviations

For pulse-arc use, the load values are reduced by up to 35%.

<i>ED</i>	Duty cycle
<i>MIG</i>	Metal inert gas
<i>MAG</i>	Metal active gas
<i>MAC value</i>	Maximum allowable concentration of harmful substances in the workplace
<i>Voltage rating</i>	Insulation resistance, electric strength, and protection class
<i>TCP</i>	Tool center point

6.6 The type plate

Robot Gun Mount T3 is identified by a sticker or a Kemppi logo. When contacting the service staff, please remember to check the production stamp near the Kemppi logo.

Figure 3: T3 type plate

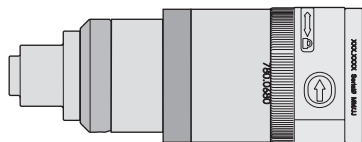

- Serial number
- Flange serial number
- F intermediate flange serial number

7. DELIVERY SCOPE

The delivery for a gas-cooled gun includes the following components:

- Kemppi Robot Gun Mount T3
- Operating instructions
- Cylinder-head screws, M4×10 (4 pcs.)
- Certificate of conformity
- Screwdriver for hexagon-head screws, wrench size 2.5
- Sealing grease, silicone-free, 10 g can

The equipment parts and wear parts are ordered separately.

Order data and ID codes for the equipment parts and wear parts can be found in the current catalogue. Contact details for advice and for placing orders can be found online at www.kemppi.com.

8. TRANSPORT

The components are carefully checked and packed; however, damage may still occur during shipping.

<i>Checking procedure on receipt of goods</i>	Check that the shipment is correct by referring to the shipping note.
<i>In case of damage</i>	Check the package and components for damage (perform a visual inspection).
<i>In the event of problems</i>	If the goods have been damaged during transport, contact the last carrier immediately. Keep the packaging (for possible checks by the carrier).
<i>Packaging for return of the goods</i>	Use the original packaging and the original packaging material. If you have questions about the packaging and safety during shipment, please consult your supplier.

9. STORAGE

The physical conditions for storage in a closed room are -10 °C to 55 °C.

10. FUNCTIONAL DESCRIPTION

The Kemppi Robot Gun Mount T3 unit is used for accommodating welding guns in the exact position needed. The mount is fastened to the robot by means of cylinder-head screws and a plastic intermediate flange. In order to cover the required performance ranges, there are two distinct mount versions available:

- A gas-cooled version
- A liquid-cooled version

For Robot Gun Mount T3, the TCP coordinates are the same as the coordinates of the corresponding welding gun.

Two types of standard welding guns are available for Robot Gun Mount T3, the gas-cooled A7 MIG Gun 500-g and the water-cooled A7 MIG Gun 500-w.

Robot Gun Mount T3 does not have integrated collision protection. Collision protection or switching off of the robot can be performed only by robot control.

11. INSTALLING ROBOT GUN MOUNT T3

! Risk of injury due to unexpected start-up

For the entire duration of maintenance, servicing, unmounting, and repair work, the following instructions must be adhered to:

- Switch off the power supply.
- Cut off the compressed air supply.
- Pull the power plug.

i Read the safety instructions in this manual and the separate safety instructions. The system may only be installed by authorized personnel.

11.1 Fastening Robot Gun Mount T3 to the robot

This section describes how to fasten the robot mount to the robot.

The parts of the system are depicted in the figure below.

Figure 3: Fastening Robot Gun Mount T3 to the robot

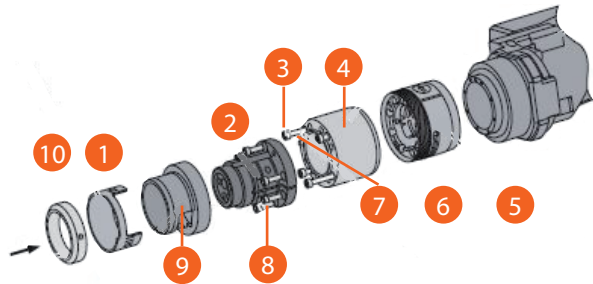

- | | |
|------------------------------------|-----------------------------|
| 1. Lock ring | 6. Intermediate flange |
| 2. Complete welding torch coupling | 7. Cylindrical pin |
| 3. 4 cylinder screws, M5×50 | 8. 6 cylinder screws, M5×16 |
| 4. Insulating flange | 9. Insulating sleeve |
| 5. Robot | 10. Retaining ring |

i For fastening Robot Gun Mount T3 to the robot, a robot flange (2) is required. It must correspond to the hole pattern of the robot mount (1) and of the robot.

Proceed as follows:

1. Mount the intermediate flange (6) on the robot (5), using eight (M4) cylinder-head screws. Max. tightening torque $M = 3.5 \text{ Nm}$
2. Fasten the insulating flange (4) to the intermediate flange (6), using four cylinder screws (3). Max. tightening torque $M = 6 \text{ Nm}$

i Make sure that the cylindrical pin (7) is in the correct position. It specifies the reference position in relation to the robot.

3. Fasten the complete welding torch coupling (2) to the insulating flange (4), using six cylinder screws (8). Max. tightening torque $M = 3.5 \text{ Nm}$.
4. Mount the insulating sleeve (9) and the lock ring (1) on the complete welding torch coupling (2), and secure with the retaining ring (10).

11.2 The maintenance position of the robot

This section describes how to place the robot in maintenance position.

Before Robot Gun Mount T3 and the cable assembly can be mounted, the robot must be placed in maintenance position.

i For correct attachment of the robot mount and the cable assembly, set the 4th axis = neutral position, 5th axis = inclined by 10°, and 6th axis = neutral position.

Figure 4: Overview of the robot axes

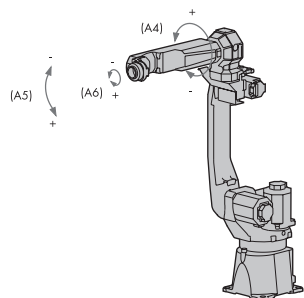

For standard welding positions, we recommend the following axis positions for the mounting of the hose assembly.

Figure 5: Standard axis positions

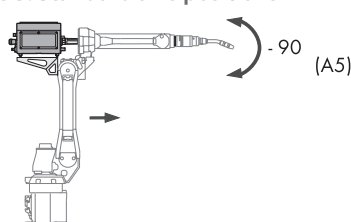

For determining the optimal position of the wire feeder at extreme welding positions, we recommend the following axis positions:

- $A6 > \pm 100^\circ$
- $A5 > \pm 90^\circ$
- $A4 > \pm 100^\circ$

This procedure avoids putting extreme stress on the hose assembly.

Proceed as follows:

1. Unscrew the wire feeder (1).
2. Align the hose assembly (2) in the predetermined direction, and mount it in the gun mount.

11.3 Mounting the hose assembly on the robot

This section describes how to mount the hose assembly on the robot.

! *Serious injuries can be caused by parts articulating rapidly. When cleaning with compressed air, wear suitable protective clothing – in particular, safety goggles.*

i *When replacing the liquid-cooled A7 MIG Gun 500-w hose assemblies, make sure that any coolant residues are removed from the robot mount.*

- When replacing the liquid-cooled A7 MIG Gun 500-w hose assemblies, make sure that any coolant residues are removed from the robot mount.
- When mounting liquid-cooled A7 MIG Gun 500-w hose assemblies, make sure that the water nipples in the welding torch coupling for the A7 MIG Gun 500-w unit are inserted correctly into the hose assembly adapter. Observe the forced positioning.
- After mounting is complete, check for any leaks.

Before Robot Gun Mount T3 and the cable assembly can be mounted, the robot must be placed in maintenance position.

Figure 6: Mounting the hose assembly – Fanuc only

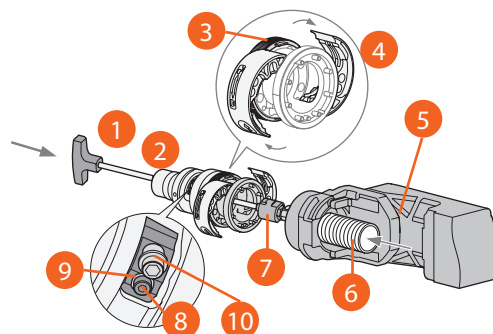

1. Pull-in tool
2. Robot mount
3. Lock ring
4. 2 covers
5. Robot
6. Hose assembly
7. Hose assembly connection
8. Complete welding torch coupling
9. Washer
10. Fastening screw

Proceed as follows:

1. Rotate the lock ring (3), and open the cover (4).
2. Unscrew the fastening screw (10) from the welding torch coupling (8) until the screw head and the washer (9) make contact.
3. Introduce the hose assembly (6) from behind, through the robot (5).
4. Insert the pull-in tool (1) from the front, through the robot mount (2) and the robot (5), and screw it into the hose assembly connection (7) as far as it will go.

i *Only if the hose assembly connection has been correctly inserted can it be attached properly with the fastening screw.*

5. Position the hose assembly connection (7) with the positioning pin and the groove of the welding torch coupling (8).
6. Pull in the hose assembly connection (7) as far as it will go, and secure it with a fastening screw (10), with max. tightening torque $M = 7.5 \text{ Nm}$. Observe the forced positioning.
7. Unscrew the pull-in tool (1).
8. Slide in the corrugated hose on the hose assembly (6) as far as it will go.
9. Close the cover (4), and tighten with the lock ring (3). Refer to Figure 4 for the standard axis positions.
10. Fasten the wire feeder (1) to the wire bracket mount (3).
11. The position of the wire feed (1) is due to the position of the robot (maintenance position). Make sure that the hose assembly can still be moved 20 mm upwards and downwards after the wire feeder has been attached.

11.4 Attaching the A7 MIG G gun neck

This section describes how to attach the A7 MIG G gun neck.

Figure 7: Attaching the A7 MIG G gun neck

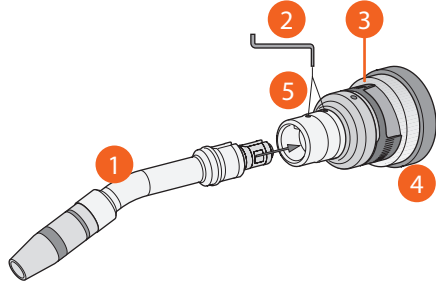

1. A7 MIG 500-g gun neck
2. Hexagon wrench
3. Lock ring
4. Robot mount
5. 2 set screws

Proceed as follows:

1. Equip the A7 MIG 500-g gun neck (1) with a tip adapter, contact tip, and gas nozzle.
2. Insert the A7 MIG 500-g gun neck (1), via the guide grooves, into the robot mount (4) as far as it will go.
3. Tighten the set screws (5) with a hexagon wrench (2). Tightening torque $M = 2.5 \text{ Nm}$.
4. Close the lock ring (3) by rotating it to the left.

11.5 Attaching the A7 MIG W gun neck

This section describes how to attach the A7 MIG W gun neck.

Figure 8: Attaching the A7 MIG W gun neck

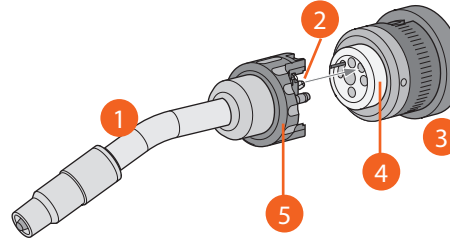

1. A7 MIG gun neck 500-w
2. Positioning pin
3. Robot mount
4. Connection module
5. Retaining nut

Proceed as follows:

1. Equip the A7 MIG gun neck 500-w (1) with a tip adapter, contact tip, and gas nozzle.
2. Introduce the positioning pin (2) into the marked bore. The gun neck (1) can only be fastened in this position.
3. Tighten the gun neck (1) with the retaining nut (5) on the robot mount (3).
4. The gun neck (1) is now attached.

i After the gun has been in use for several days, it may no longer be possible to disconnect it by hand. To disconnect it, use a suitable wrench. Do not use pliers to disconnect the gun.

11.6 Mounting the wire liner

This section describes how to equip the cable assembly with a wire liner.

i The new unused wire liner has to be shortened to the actual length of the hose assembly.

For handling the wire liner, please observe the enclosed wire guide mounting instructions.

Figure 9: Mounting the wire liner

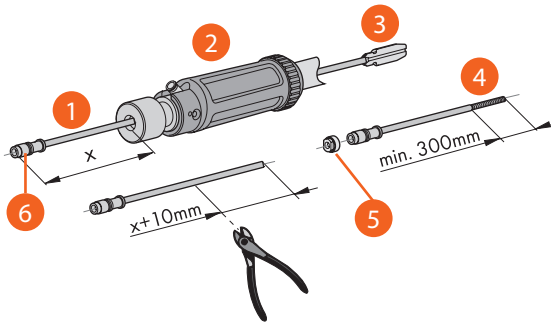

1. Wire liner
2. Cable assembly
3. Contact tip
4. Insulation sheathing
5. Fastening nut
6. O-ring

Proceed as follows:

1. Lay out the cable assembly (2) straight.
2. Introduce the wire liner (1) through the cable assembly (2) into the contact tip (2), all the way.
3. Check the excess length x of the wire liner (1), and remove the wire liner (1).
4. Reduce the excess length $x + 10$ mm from the front.
5. Remove 300 mm of the insulation sheathing (4) from the wire liner on the gun side.
6. Remove the burr formed by the shortening operation at the wire liner (1).
7. Mount the wire liner (1) with excess length (10 mm maximum) in the cable assembly (2).
8. Mount the wire liner (1) in the cable assembly (2), and screw the nut (5) in.
9. Make sure that the O-ring (6)
 - has been greased with sealing grease (included in the delivery)
 - has been mounted on the compression sleeves

12. OPERATION

 *The device may only be operated by qualified personnel.*

Because the robot mount is integrated into the gun's welding process, the operation steps are performed after the relevant gun has been installed.

Please observe the operating instructions for the A7 MIG Gun 500-g or the A7 MIG Gun 500-w welding guns, as appropriate.

13. UNMOUNTING

 *Unmounting may only be carried out by specialist personnel. Please make sure that the shutdown procedures for all components mounted in the welding system are strictly observed before removal from operation begins.*

 *Risk of injury due to unexpected start-up*

For the entire duration of maintenance, servicing, unmounting, and repair work, the following instructions must be adhered to:

- Switch off the power supply.
- Cut off the compressed air supply.
- Pull the power plug.

The details of removal from operation depend on the model of welding gun. Please observe the operating instructions for the A7 MIG Gun 500-g or the A7 MIG Gun 500-w welding guns, as appropriate.

14. MAINTENANCE AND CLEANING

Scheduled maintenance and cleaning are prerequisites for a long service life and trouble-free operation.

Once a month, thoroughly clean the robot mount to remove all dirt and welding spatter.

 *Risk of injury due to unexpected start-up*

For the entire duration of maintenance, servicing, unmounting, and repair work, the following instructions must be adhered to:

- Switch off the power supply.
- Cut off the compressed air supply.
- Pull the power plug.

 *Electric shock*

Dangerous voltages can be produced because of defective cables.

- Check all live cables and connections for proper installation.
- Replace any parts that have suffered damage, deformation, or wear.

 *The maintenance intervals listed are recommended values and assume single-shift operation.*

- Maintenance and cleaning work may only be carried out by qualified and trained specialists.
- Always wear your personal protective clothing when performing maintenance and cleaning work.
- When replacing the liquid-cooled A7 MIG Gun 500-w hose assemblies, make sure that any coolant residues are removed from the robot mount.
- The maintenance intervals listed are recommended values and assume single-shift operation.

14.1 Cleaning robot mount T3 with A7 MIG Gun 500-g

This section describes how to clean the robot mount with A7 MIG Gun 500-g.

Figure 10: Cleaning robot mount T3 with A7 MIG Gun 500-g

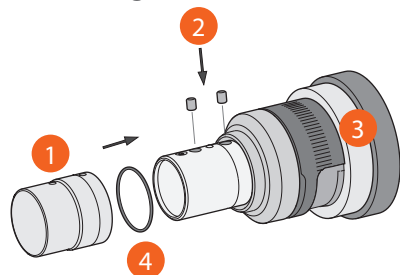

1. Cover ring
2. 2 set screws
3. Robot mount
4. O-ring

! *Serious injuries can be caused by parts articulating rapidly. When cleaning with compressed air, wear suitable protective clothing – in particular, safety goggles.*

Proceed as follows:

1. Clean the robot mount (3) with compressed air.
2. Turn the cover ring (1) to the right until the stop, and remove it.
3. Check the O-ring (4) for wear, and replace it if necessary.
4. Clean the bores of the set screws (2) with compressed air.
5. Check the set screws (2) for wear, and replace them if necessary.
6. Grease the O-rings (4) with sealing grease (included in the delivery).
7. Mount the set screws (2), O-ring (4), and cover ring (1).

14.2 Cleaning robot mount T3 with A7 MIG Gun 500-w

This section describes how to clean the T3 robot mount with A7 MIG Gun 500-w.

Figure 11: Cleaning robot mount T3 with A7 MIG Gun 500-w

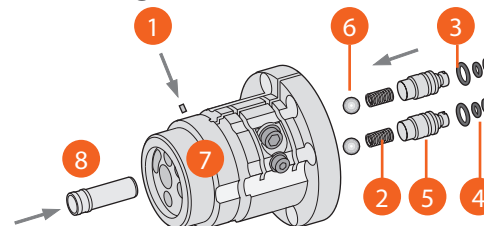

1. Set screw, M3×3
2. 2 compression springs
3. 2 O-rings, 7×1.5
4. 4 O-rings, 3.5×1.5
5. 2 compression sleeves
6. 2 balls
7. Robot mount
8. Gas duct

! *Serious injuries can be caused by parts articulating rapidly. When cleaning with compressed air, wear suitable protective clothing – in particular, safety goggles.*

Proceed as follows:

1. Clean the robot mount (7) with compressed air.
2. Grease the O-rings (3) with sealing grease (included in the delivery).
3. Mount the O-rings (3 and 4) on the compression sleeves (5).
4. Mount the balls (6), compression springs (2), and compression sleeves (5).
5. Detach the set screw (1) and gas duct (8), and check them, replacing if necessary.
6. Attach the set screw (1) and gas duct.

14.3 Cleaning the wire liner

This section describes how to clean the wire liner.

Figure 12: Cleaning the wire liner

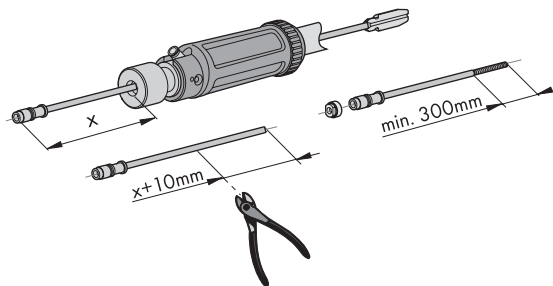

! *Serious injuries can be caused by parts articulating rapidly. When cleaning with compressed air, wear suitable protective clothing – in particular, safety goggles.*

Proceed as follows:

1. At the appropriate maintenance and cleaning intervals, check the O-ring (6) for wear and replace it if necessary.

15. TROUBLESHOOTING

 Risk of injury due to unexpected start-up

For the entire duration of maintenance, servicing, unmounting, and repair work, the following instructions must be adhered to:

- Switch off the power supply.
- Cut off the compressed air supply.
- Pull the power plug.

In the event of any doubts or problems, please contact your retailer or the manufacturer.

 Please also consult the operating instructions for the other welding components, such as the power supply or air pressure line.

<i>Problem</i>	<i>Cause</i>	<i>Solution</i>
Problems in mounting the hose assembly on the robot mount	No grease on the O-rings of the adapter	Grease the O-rings with sealing grease (included in the delivery)
	The hose assembly adapter is not correctly inserted into the module	Use the pull-in tool
Hose assembly creates ripples in the robot axis	Hose assembly too long	Change the feeding system positioning, if possible

16. REMOVING THE MOUNT

This section describes how to remove robot mount T3.

i *Unmounting may only be carried out by specialist personnel. Please make sure that the shutdown procedures are strictly observed before the unmounting work begins. Ensure this also for the components integrated into the welding system.*

! *Risk of injury due to unexpected start-up*

For the entire duration of maintenance, servicing, unmounting, and repair work, the following instructions must be adhered to:

- Switch off the power supply.
- Cut off the compressed air supply.
- Pull the power plug.

Removal from operation depends on the type of welding gun. Please observe the operating instructions of the A7 MIG Gun 500-g or the A7 MIG Gun 500-w welding guns, as appropriate.

Proceed as follows:

1. Disconnect the hose assembly from the wire feeder.
2. Open the lock ring, and unscrew the fastening screw. See Section 11.3.
3. Pull out the hose assembly.
4. Disconnect the gun neck, and remove it. See sections 11.4 and 11.5.

16.1 Disposal

For disposal, the locally applicable regulations, laws, provisions, standards, and guidelines must be observed. For the welding torch system to be properly disposed of, it must be unmounted first.

16.2 Materials

This product consists for the most part of plastics, steel, and non-ferrous metals. Steel and non-ferrous metals can be melted down, so iron products are almost infinitely recyclable. The plastic materials used are marked in preparation for appropriate sorting of the materials for later recycling.

16.3 Consumables

Oils, greases, and cleaning agents must not contaminate the ground or enter the sewer system. These materials must be stored, transported, and disposed of in suitable containers. Please observe the relevant local regulations and the disposal instructions on the safety data sheets supplied by the manufacturer of the consumables. Also, contaminated cleaning tools (brushes, rags, etc.) must be disposed of in accordance with the information provided by the manufacturer of the consumables.

16.4 Packaging

The shipping packaging has been reduced to a minimum. Packaging materials are always selected with attention to their recyclability.

17. CODES FOR ORDERING

<i>Robot gun mount</i>	<i>Product code</i>
Robot Gun Mount T3 W	SP600574
Robot Gun Mount T3 G	SP600575
Intermediate model (Swivel) for Fanuc	SP600573

<i>Accessories</i>	<i>Product code</i>
Pull-in tool	SP600579

The pull-in tool accessory serves for the correct mounting of cable assemblies. The O-rings at the rod of the pull-in tool indicate the mounting positions of cable assembly versions A7 MIG Gun 500-g and A7 MIG Gun 500-w. The pull-in tool must only be used for Robot Gun Mount T3.

Adapter flange for robot 6th axis for correct type flange inform Kemppi about robot manufacturer and robot model.

