

Operation instruction • english
Gebrauchsanweisung • deutsch
Gebruiksaanwijzing • nederlands
Manuel d'utilisation • français

1931550E
0612

WELDFORCE

KWF 200, 300, 200S, 300S



CONTENTS

1. PREFACE	3
1.1. INTRODUCTION.....	3
1.2. PRODUCT INTRODUCTION	3
1.2.1. OPERATION CONTROL AND CONNECTORS	4
1.2.2. CONNECTION OF SYSTEM	6
1.2.3. PARTS OF WIRE FEED MECHANISM.....	7
1.3. OPERATION SAFETY.....	8
2. INSTALLATION	9
2.1. ASSEMBLY OF MIG SYSTEM.....	9
2.2. ACCESSORIES CORRESPONDING TO WIRE DIAMETER.....	10
2.3. MOUNTING OF MIG WELDING GUN	10
2.4. MOUNTING AND LOCKING OF WIRE REEL.....	11
2.5. AUTOMATIC WIRE FEED TO GUN	11
2.6. ADJUSTMENT OF PRESSURE.....	12
2.7. ADJUSTMENT OF TIGHTNESS OF REEL BRAKE.....	12
2.8. BURN BACK TIME	12
2.9. GROUND CABLE.....	12
2.10. SHIELD GAS.....	13
2.10.1. INSTALLING GAS BOTTLE	13
2.11. MAIN SWITCH I/O.....	14
2.12. OPERATION OF COOLING UNIT, KWU10.....	14
2.13. HANGING.....	14
3. CONTROL PANELS OPERATIONS	14
3.1. KWF 200S AND KWF 300S OPERATIONS	14
3.2. KWF 200 AND KWF 300 OPERATIONS.....	16
4. OPERATIONS OF REMOTE CONTROL UNITS IN KWF WIRE FEED UNIT	22
5. WELDFORCE ERROR CODES	23
6. SERVICE, OPERATION DISTURBANCES	24
7. DISPOSAL OF THE MACHINE	24
8. ORDERING NUMBERS	25
9. TECHNICAL DATA	27
10. TERMS OF GUARANTEE	28

1. PREFACE

1.1. INTRODUCTION

Congratulations on having purchased this product. Properly installed Kemppi products should prove to be productive machines requiring maintenance at only regular intervals. This manual is arranged to give you a good understanding of the equipment and its safe operation. It also contains maintenance information and technical specifications. Read this manual from front to back before installing, operating or maintaining the equipment for the first time. For further information on Kemppi products please contact us or your nearest Kemppi distributor.

The specifications and designs presented in this manual are subject to change without prior notice.

In this document, for danger to life or injury the following symbol is used: 

Read the warning texts carefully and follow the instructions. Please also study the Operation safety instructions and respect them when installing, operating and servicing the machine.

1.2. PRODUCT INTRODUCTION

Kemppi WeldForce KWF is wire feeder designed for demanding professional use.

Introducing units KWF 200 and KWF 300, members of our product family designed to suit 200-mm and 300-mm wire reel requirements. Units KWF 200S and KWF 300S are identical to the parent unit's, but equipped with less extensive range of functions.

Operations of wire feed unit are controlled and adjusted with microprocessor.

This manual provides instructions on the start-up of the KWF 200, KWF 300, KWF 200S and KWF 300S MIG units and the functions of the wire feed unit.

 **This equipment's electromagnetic compatibility (EMC) is designed for use in an industrial environment. Class A equipment is not intended for use in residential location where the electrical power is provided by the public low-voltage supply system.**

1.2.1. Operation control and connectors

KWF 200 and 200S



KWF 300 and 300 S



Functions of KWF 200S and KWF 300S function panel

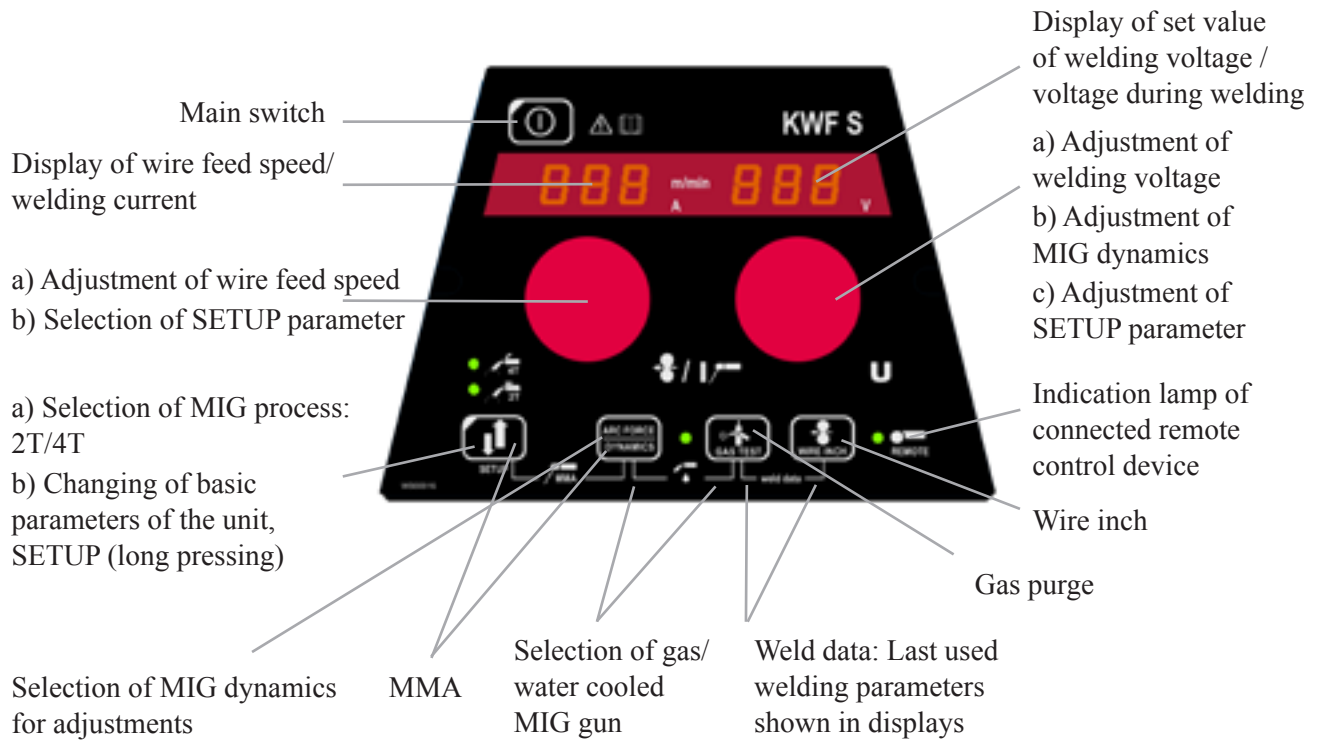

Functions of KWF 200 and KWF 300 function panel

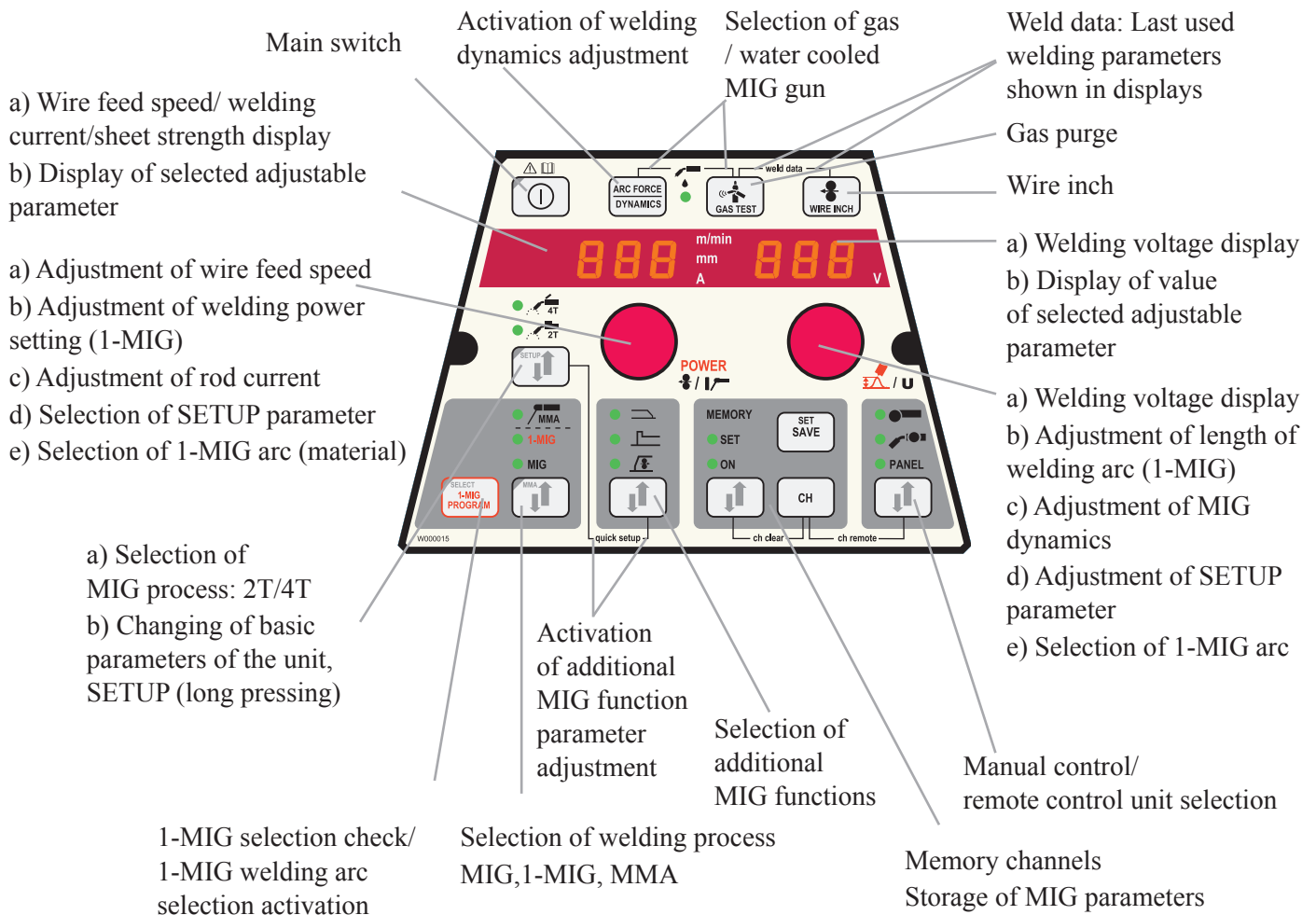

1.2.2. Connection of system

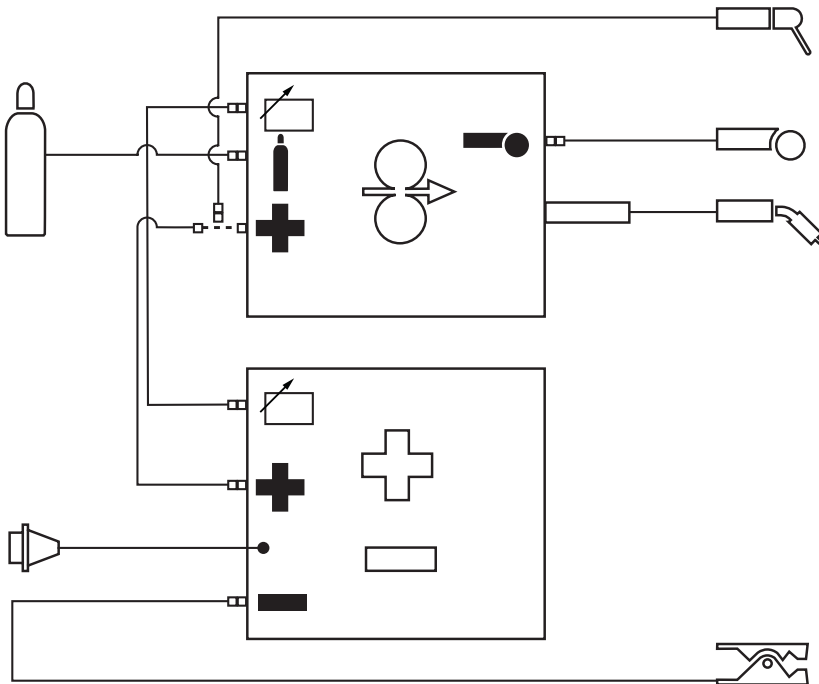
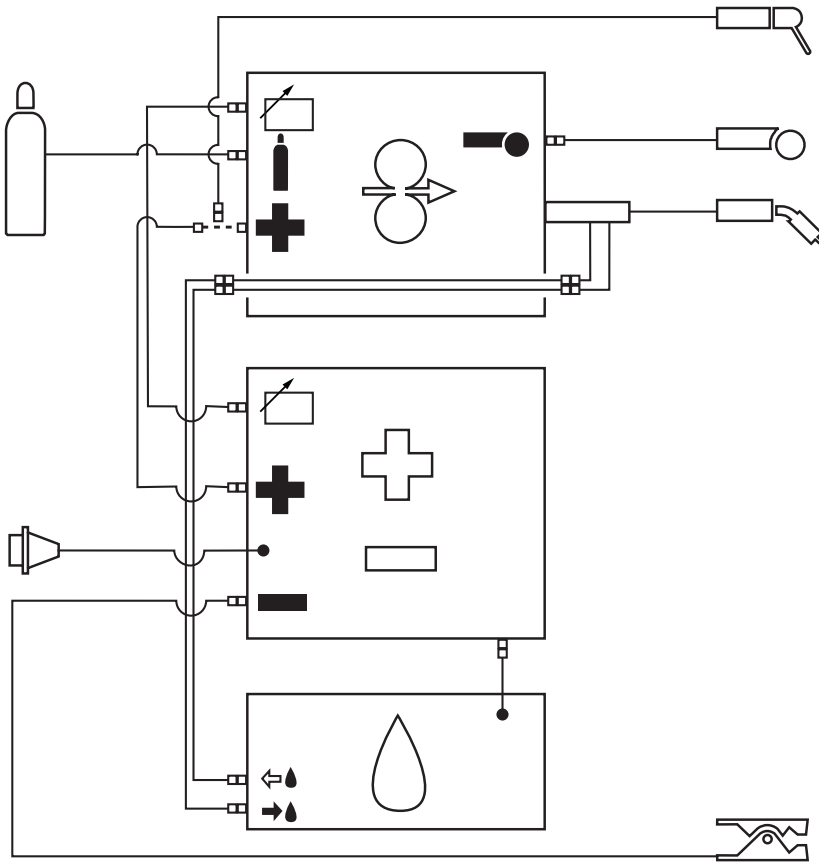

1.2.3. Parts of wire feed mechanism WeldForce KWF 200, KWF 300

4 - roll wire feed mechanism



Wire guide tubes

Fe	$\varnothing 0,6...0,8$ mm white	$\varnothing 1,0$ mm 3134140	$\varnothing 2,0$ mm orange	$\varnothing 2,0$ mm 3134120	$\varnothing 2,0$ mm plastic	$\varnothing 2,4$ mm yellow
Mc	$\varnothing 0,9...1,6$ mm orange	$\varnothing 2,0$ mm 3133700	$\varnothing 4,0$ mm blue	$\varnothing 4,0$ mm 3134110	$\varnothing 4,0$ mm brass	Promig 511
Fc	$\varnothing 1,6...2,4$ mm blue	$\varnothing 4,0$ mm 3134130	$\varnothing 2,5$ mm silver	$\varnothing 2,5$ mm 3134300	$\varnothing 2,0$ mm plastic	$\varnothing 3,0$ mm yellow
Ss	$\varnothing 0,8...1,6$ mm silver	$\varnothing 2,5$ mm 3134290				
Al	$\varnothing 1,6...2,4$ mm yellow	$\varnothing 3,0$ mm 3134710				

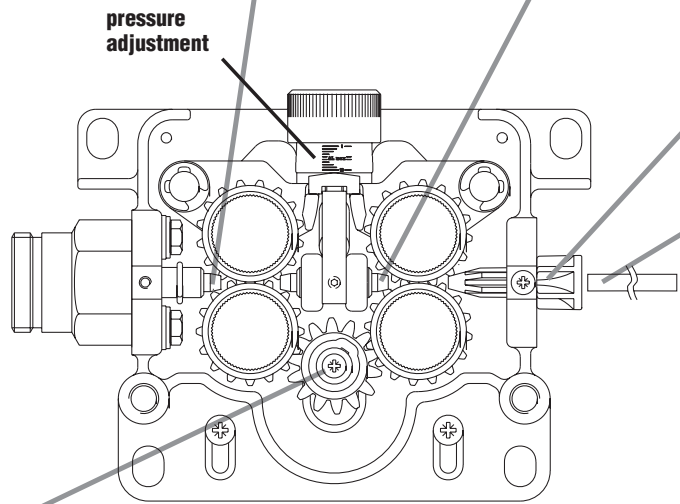

pressure adjustment

Syöttöpöyrän uran valinta, val av matarhjulspår, valg av matehjul spor, valg af spor i trådihjul, selection of feed wheel groove, Auswahl der Transportrollennut, selectie van de draaddiameter groef, sélection de la gorge du galet

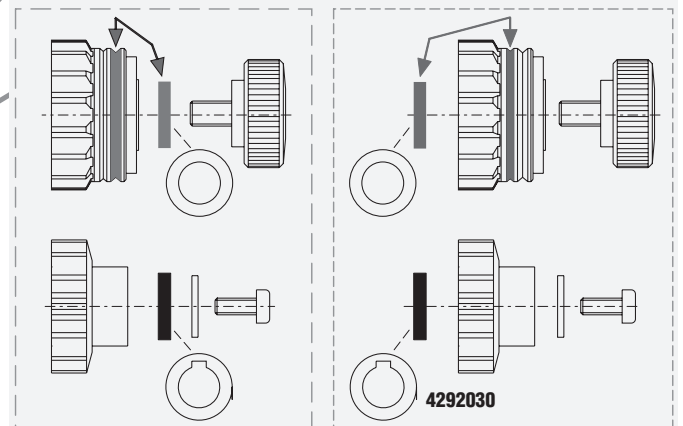

Vetoratas, drivhjul, trekkannahjul, drivhjul, gearwheel, Aufziehrad, aandrijfrol, galet d'entrainement

$\varnothing 28$ mm (0 - 18 m/min) 4265240, $\varnothing 40$ mm (0 - 25 m/min) 4265250

Muovi, plast, plast, plastic, plastic, Kunststoff, plastic, plastique

$\varnothing 28$ mm (0 - 18 m/min) 4287860, $\varnothing 40$ mm (0 - 25 m/min) 4297270

Teräs, stål, stål, stål, steel, Stahl, staal, acier

Vetorattaan valintalevyn siirto, flytning av distansbricka, flytning av avstandsskive for matehjul, hvordan flytter man justerskiven, relocation of selection plate, Versetzen der Wahlschalterplatte, verplaatsing van selectie plaat, remise en place de la rondelle de sélection

Feed rolls



Fe Ss Al	Plain	$\varnothing 0,6/0,8$ $\varnothing 0,8/0,8$ (L) white	$\varnothing 1,0/1,2$ 3133810	$\varnothing 1,0/1,0$ (L) 3138650 $\varnothing 1,2/1,2$ (L) 3137390 red orange	$\varnothing 1,4-1,6/2,0$ 3133820	$\varnothing 2,4$ black $\varnothing 3,2$ blue	3133880
			$\varnothing 1,6/1,6$ (L) 3141120		3133910		
Fe Fc Mc	Knurled	$\varnothing 1,0/1,2$ $\varnothing 1,2/1,2$ (L) red orange	$\varnothing 1,0/1,2$ 3133940	$\varnothing 1,4-1,6/2,0$ $\varnothing 1,6/1,6$ (L) red orange yellow	$\varnothing 2,4$ 3133990	$\varnothing 2,4$ black $\varnothing 3,2$ blue	3134030
			$\varnothing 1,2/1,2$ (L) 3137380		3134060		
Fe Fc Mc Ss Al	Trapezoid	$\varnothing 1,2/1,2$ (L) orange	$\varnothing 1,4/1,4$ (L) 3142210	$\varnothing 1,4/1,4$ (L) brown $\varnothing 1,6/1,6$ (L) yellow	$\varnothing 2,0/2,0$ (L) 3142230	$\varnothing 2,4$ (L) grey $\varnothing 2,4$ (L) black	3142230
			$\varnothing 1,6/1,6$ (L) 3142200		3142240		

(L) = Ball race

W000574

1.3. OPERATION SAFETY

Please study these Operation safety instructions and respect them when installing, operating and servicing the machine.

Welding arc and spatters

Welding arc will hurt unprotected eyes, also be very careful with reflecting arc flash. Welding arc and spatter will burn unprotected skin. Therefore it is highly recommended to always use safety gloves and protective clothing.

Danger for fire or explosion

Pay attention to fire safety regulations. Remove flammable or explosive materials from welding area. Always reserve sufficient fire-fighting equipment on welding area. Be prepared for hazards in special welding jobs, eg. for the danger of fire or explosion when welding container type work area. Note! Fire can break out from sparks even several hours after the welding work has been finished!

Mains voltage

Never take welding machine inside a work area (eg. container or truck). Do not place welding machine on a wet surface. Always check cables before operating the machine. Change defect cables without delay. Defect cables may cause an injury or set out a fire. Connection cable must not be compressed, it must not touch sharp edges or hot work pieces.

Welding power circuit

Isolate yourself by using proper protective clothing, do not wear wet clothing. Never work on a wet surface or use defect cables. Do not put MIG-gun or welding cables on welding machine or on other electric equipment. Do not press MIG-gun switch, if the gun is not directed towards a work piece.

Welding fumes

Take care that there is sufficient ventilation during welding. Take special safety precautions when welding metals, which contain lead, cadmium, zinc, mercury or beryllium.

2. INSTALLATION

2.1. ASSEMBLY OF MIG SYSTEM

Assemble the units in order mentioned below and follow mounting and operation instructions which are delivered in packages.

1. Installation of power source

Read paragraph: "Installation" in operation instructions for Kemppi WeldForce power sources and carry out the installation according to that.

2. Mounting of KPS power sources to transport wagon

Read and follow the instructions given in the transport cart installation/assembly manual

3. Put the WeldForce KWF onto the power source

4. Connecting cables

Connect the cables in accordance with the equipment notes provided.

The polarity of the welding wire (+ or -) can be changed by replacing the KWF welding current cable and return current cable with the Kemppi WeldForce power source welding cable connector.

5. Max. wire feed speed

When the unit is delivered the max. wire feed speed is 18 m/min, which is enough for most welding works. If you need a higher speed, you can increase the max. wire feed speed to 25 m/min by replacing the gear wheel on motor shaft to a bigger one. The big gear wheel D40 is delivered with the feed unit.

When necessary speed is changed according to following:

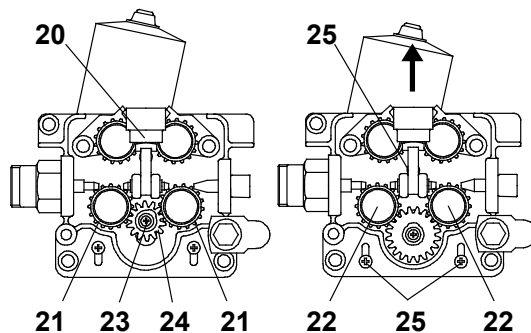

- Change the SETUP function to the 25 m/min maximum wire feed speed. See 'changing SETUP settings' for instructions.
- Open tightening lever (20). Remove lower feed rolls (21). Release screw (23) and its washer. Remove gear wheel D28 (24) from motor shaft.
- Loosen screws (25) (3 pc) 1 twist. Mount the D40 gear wheel onto motor shaft. Screw the screw (23) with its washer back.
- Put feed rolls (21) back to their axles, however, do not fasten the fastening screws of feed rolls yet (22).
- Lift the motor so that the tooth gap between gear wheel and both lower feed rolls is approx. 0,2 mm.
- Tighten screws (25). Check gear teeth gaps, when necessary put the motor into a better position. Screw on the mounting screws of feed rolls (22).



If the gap is too small between gear wheel and feed rolls it will overload the motor. If gap is too big for its part might cause too rapid wearing for teeth of feed rolls and gear wheel.

6. Mounting of WeldForce wire feed units to boom

 Wire feed unit must be mounted to boom in such a way that its chassis is galvanic separated both from swing arm and boom.

Suspension angle of wire feed unit can be changed by moving fixing point in handle.

2.2. ACCESSORIES CORRESPONDING TO WIRE DIAMETER

Wire feed rolls are available with plain groove, knurled groove and with U groove for different purposes.

Feed rolls with plain groove: Universal feed roll for welding of all kinds of wires.

Feed rolls with knurled groove: Special feed roll for cored wires and steel wires.

Feed rolls with U groove: Special feed roll for aluminium wires.

Trapezoid slotted, ball bearing feed wheels: For heavy welding

Wire feed rolls has two grooves for different filler wire diameters. Correct wire groove is selected by moving selecting washer (28) from one side to another in feed roll.

Feed rolls and wire guide tubes of wire feed unit have colour codes in order to make identification easier.

Feed rolls		
colour filler wire	ø mm	inch
white	0.6 and 0.8	0.030
red	0.9/1.0 and 1.2	0.035, 0.045 and 0.052
yellow	1.4, 1.6 and 2.0	1/16 and 5/64
black	2.4	3/32
Guide tubes		
colour filler wire	ø mm	inch
orange	0.6-1.6	0.024-1/16
blue	over 1.6	over 1/16

In delivery WeldForce wire feed units are equipped with red feed rolls with plain groove and with orange wire guide tubes for welding filler wires of 0.9 – 1.2 mm (0.035", 0.045" and 0.052").

2.3. MOUNTING OF MIG WELDING GUN

In order to ensure trouble-free welding check in operation instructions of gun used by you that wire guide tube and contact tip of gun are according to manufacturer's recommendation suitable to be used for wire feed diameter and type in question. To tight a wire guide tube might cause for wire feed unit a bigger stress than normally as well as disturbances in wire feed.

Screw snap connector of gun tight that there won't come any voltage losses on connecting surface.

A loose connection will heat gun and wire feed unit and feeder.

KWF wire feed units are equipped with backup functions in case of overheating of the liquid-cooled PMT and WS gun or overloading of the wire feed motor. The backup function is as follows (see also the error code information, page 23):

1. The Kemppi PMT and WS gun thermal protection goes into action. When this occurs, the unit interrupts welding and the message 'Err 8' appears on the panel (ls) display.
2. The wire feed motor can overload - due to, e.g., gun clogging. In this event, the unit interrupts welding and the text 'Err 9' appears on the panel (ls) display.

Error codes Err 8 and Err 9 disappear on the next start-up if the cause of the error has been eliminated (i.e., the gun has cooled down or the motor is no longer overloaded).

2.4. MOUNTING AND LOCKING OF WIRE REEL

KWF 300/300S

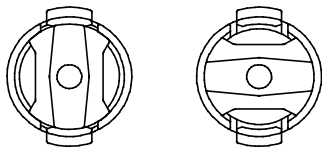

LOCKED

OPEN

- Release locking nails of wire reel hub by turning locking knob a quarter round.
- Mount the reel at its place. Note rotating direction of reel!
- Lock the reel with locking knob, locking nails of hub remain to outside position and will lock the reel.

KWF 200/200S

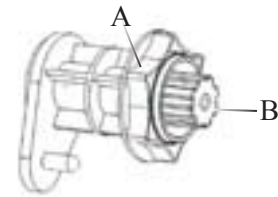

- Release the locking nub (A)!
- Mount the reel at its place. Note rotating direction of reel
- Lock the reel with locking nut.



Check that in filler wire reel there are no parts sticking out, which could e.g. chafe against chassis or door of wire feed unit. Dragging parts might expose chassis of wire feed unit under voltage.

2.5. AUTOMATIC WIRE FEED TO GUN

Automatic wire feed makes change of wire reel more rapid. In reel change the pressure of feed rolls need not to be released and filler wire goes automatically to correct wire line.

- Make sure that groove of feed roll matches the diameter of welding wire used. Feed roll groove is selected by moving the groove selecting washer (28). N.B.! Also the selector plate for changing the feed roll groove has to be moved similarly.



Moving the groove selecting washer



Moving the selectore plate

- Release the wire end from reel and cut off the bent length. Be careful that the wire does not spill from the reel to sides!
- Straighten about 20 cm of the wire and see that the end of it has no sharp edges (file off if necessary). A sharp edge may damage the wire guide tube and contact tip of the welding gun.

WeldForce KWF wire feed units:

- Draw a bit of loose wire from wire reel. Feed wire through back liner to feed rolls. Do not release pressure of feed rolls!
- Press the gun switch and feed a bit wire until wire goes through feed rolls to gun. See that wire is in grooves of both feed roll pairs!
- Press still the gun switch until wire has come through contact tip.

Automatic feed may sometimes fail with thin wires (Fe, Fc, Ss: 0,6...0,8 mm, Al: 0,8...1,0 mm). In that case you might have to open feed rolls and feed wire manually through feed rolls.

2.6. ADJUSTMENT OF PRESSURE

Adjust the pressure of feed rolls with the control screw (20) so that the wire is fed into the wire guide tube evenly and allows a little braking when coming out from the contact tip without slipping at the feed rolls.



Excessive pressure causes flattening of the filler wire and damage to the coating. It also causes undue wear of the feed rolls as well as friction.

2.7. ADJUSTMENT OF TIGHTNESS OF REEL BRAKE

KWF 300/300S

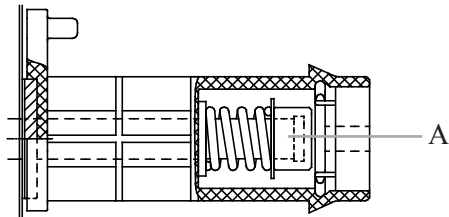

Brake force is adjusted through hole in locking device of reel hub by screwing the control screw (A) with screwdriver.

KWF 200/200S

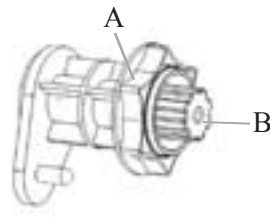

Brake force is adjusted by screwing the brake force adjusting screw (B), tightening clockwise direction.

Adjust brake force as so big that the wire is not allowed to become too loose on the reel so that it would spill from the reel when the rotation of the reel stops. Need for brake force is increased with increase of wire feed speed.

Since the brake loads for its part the motor, you shouldn't keep it unnecessarily tight.

2.8. BURN BACK TIME

Electronics of feed unit controls stopping of welding automatically so that the wire end doesn't melt fastened to the contact tip or the work piece. Automatics work regardless of the wire feed speed.

2.9. GROUND CABLE

Connecting of earth cable should be preferably connected directly to the welding material. Contact surface of press always should be as large as possible.

Clean the fastening surface from paint and rust!

Use in your MIG equipment at least 70 mm². Thinner cross-sectional areas might cause overheating of connectors and insulations.

Make sure that the welding gun in your use is designed for max. welding current needed by you!

Never use a damaged welding gun!

2.10. SHIELD GAS

⚠ Handle gas bottle with care. There is a risk for injury if gas bottle or bottle valve is damaged!

For welding stainless steels, mixed gases are normally used. Check that the gas bottle valve is suitable for the gas. The flow rate is set according to the welding power used in the job. A suitable flow rate is normally 8 – 10 l/min. If the gas flow is not suitable, the welded joint will be sporous. Contact your local Kemppi-dealer for choosing gas and equipment.

2.10.1. Installing gas bottle

⚠ Always fasten gas bottle properly in vertical position in a special holder on the wall or on a carriage. Remember to close gas bottle valve after having finished welding.

Parts of gas flow regulator

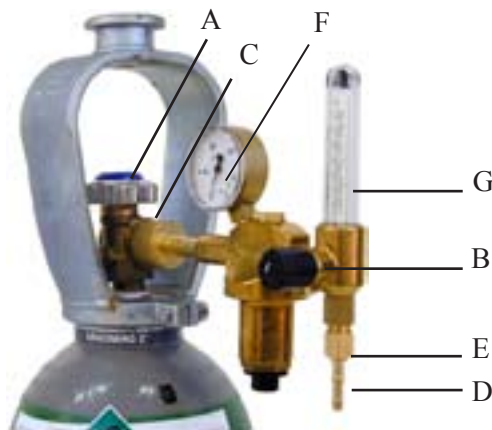

- A Gas bottle valve
- B Press regulation screw
- C Connecting nut
- D Hose spindle
- E Jacket nut
- F Gas bottle pressure meter
- G Gas hose pressure meter

The following installing instructions are valid for most of the gas flow regulator types:

1. Step aside and open the bottle valve (A) for a while to blow out possible impurities from the bottle valve.
2. Turn the press regulation screw (B) of the regulator until no spring pressure can be felt.
3. Close needle valve, if there is one in the regulator.
4. Install the regulator on bottle valve and tighten connecting nut (C) with a wrench.
5. Install hose spindle (D) and jacket nut (E) into gas hose and tighten with hose clamp.
6. Connect the hose with the regulator and the other end with the wire feed unit. Tighten the jacket nut.
7. Open bottle valve slowly. Gas bottle pressure meter (F) shows the bottle pressure.
Note! Do not use the whole contents of the bottle. The bottle should be filled when the bottle pressure is 2 bar.
8. Open needle valve if there is one in the regulator.
9. Turn regulation screw (B) until hose pressure meter (G) shows the required flow (or pressure).
When regulating flow amount, the power source should be in switched on and the gun switch pressed simultaneously.

Close bottle valve after having finished welding. If the machine will be out of use for a long time, unscrew the pressure regulation screw.

2.11. MAIN SWITCH I/O

When you turn the main switch of the Kemppi WeldForce power source into I-position, the pilot lamp closest to this switch will light up, indicating the power source is ready for welding. The equipment is returned to the position which it last carried out before the main switch was turned to zero position.

⚠ Always start and switch off the machine with the main switch, never use the mains plug as a switch.

2.12. OPERATION OF COOLING UNIT, KWU10

Operation of cooling unit is controlled in such a way that pump is started when welding is started. After welding stop pump is rotating for approx. 5 min cooling the liquid to ambient temperature. Read in operation instructions for the KWU10 unit the trouble situations of the liquid circulation system and protection against torch etc. damage.

2.13. HANGING

KWF 200 needs hanging frame (accessorie) for mounting, do not hang from the handle. KWF 300 can be hanged from the handle.

3. CONTROL PANELS OPERATIONS

3.1. KWF 200S AND KWF 300S OPERATIONS

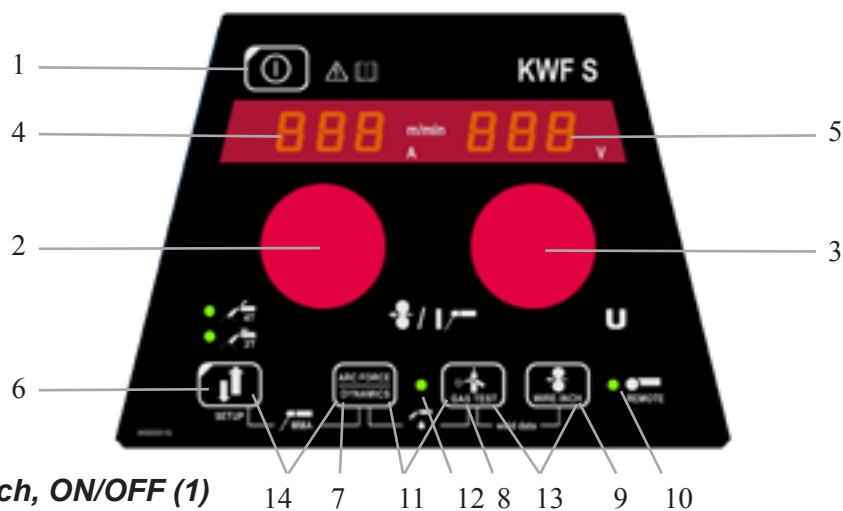

Main switch, ON/OFF (1)

The wire feed unit remains in the OFF position when the power source is switched on, thus preventing start-up.

'OFF' is shown on the display.

When the ON/OFF button is pressed for more than 1 second, the unit starts up and all LED lights light-up for a moment. The unit is now ready for welding and will automatically return back to it previous position, before the power was cut off.

Basic settings and displays (2, 3, 4, 5)

The wire feed speed is set via potentiometer No. 2, the value of which is shown on display No. 4. The welding voltage is set via potentiometer No. 3, the value of which is shown on display No. 5. During welding, display No. 4 shows the actual welding current value and display No. 5 shows welding voltage.

When MIG dynamics adjustment is activated via button No. 7, the MIG dynamics value is adjusted through potentiometer No. 3 (see 'Adjustment of MIG dynamics').

When the adjustment of SETUP parameters has been confirmed with long press on button 6, the adjustable parameter is selected via potentiometer No. 2, the name of which is shown on display No. 4 (see the information on SETUP functions).

Selection of MIG operating procedure (6)

MIG 2T: MIG welding with two-sequence procedure of welding gun start switch

1. switch pressed: welding starts
2. switch released: welding stops

MIG 4T: MIG welding with four-sequence procedure of welding gun start switch

1. switch pressed: shielding gas flow starts
2. switch released: welding starts
3. switch pressed: welding stops
4. switch released: shielding gas flow stops

Adjustment of MIG dynamics/Arc Force (7)

With MIG welding dynamics adjustment is influenced on welding stability and spatter amount. Zero setting is recommended basic setting. Values → min (-1...-9), softer arc for reduced spatter amount. Values → max (1...9), harder arc for increased stability and when 100 % CO₂ shielding gas is used when welding steel.

With electrode welding Arc Force adjustment is influenced on welding stability. Adjustment is needed for using different types of electrodes. Control range (-9...0) is commonly used for welding electrodes for stainless steel. Control range (0...+9) is used for harder arc characteristic to increase stability, e.g. for welding with thicker basic electrodes and using lower current value than recommended. Factory set value (0) is a good general use for adjusting the roughness of the arc.

Gas test (8)

The gas test button opens the gas valve without activating the wire feed or power source.

By default, gas flows for 20 seconds. The display shows the remaining gas flow time.

The default time for gas flow can be adjusted via the right-hand potentiometer within a 10- to 60-second range. The new time setting is recorded in the memory.

The gas flow can be discontinued by pressing the ON/OFF button or the start switch of the gun.

Wire feed test (9)

The wire feed switch starts the wire feed motor without opening the gas valve and without engaging the power source. The default wire feed speed is 5 m/min. The speed can be adjusted via the right-hand potentiometer.

When the button is released, the wire feed stops. Unit operation returns to normal approx. 3 seconds after release of the button or if the ON/OFF button is pressed briefly.

Selection of liquid- /gas-cooled MIG gun (11)

Selection of liquid-cooled/gas-cooled MIG gun is activated by pressing buttons 7 and 8 simultaneously (for more than 1 second). When 'Gas' is shown on the display, the welding equipment will assume that a gas-cooled MIG gun has been connected. If the above buttons are pressed again, the text 'COO Ler' appears on the display and the LED (12) indicating liquid cooling selection lights up. In this case, the welding equipment will assume that a liquid-cooled MIG gun has been connected to the equipment. When liquid cooling is selected, the liquid cooling unit will start up in connection with the next equipment start-up.

Weld data (13)

The weld data function is activated by pressing buttons 8 and 9 simultaneously. The weld data function returns the welding current and voltage values that were in use when welding was discontinued to the displays.

MMA (14)

Selection of MMA welding is activated by pressing buttons 6 and 7 simultaneously To get back to MIG welding repress buttons 6 and 7.

Use of remote control units (10)

When a remote control unit is connected to the device, LED (10) lights up and the wire feed speed and welding voltage setting operations are performed via remote control. In this case, potentiometers 2 and 3 of the panel are disconnected.

SETUP functions (6)

The unit is equipped with a number of additional functions, the selection and parameter value settings for which are performed via the SETUP function.

The SETUP function is activated by pressing the SETUP button (6) for >1 second. The adjustable parameter is selected via the left-hand potentiometer (2), the name of which is shown on display No. 4. The value of the parameter in question is adjusted via the right-hand potentiometer (3), and the value is shown on the display (5). The parameters and their possible values are:

Name of parameter	Name on display	Parameter values	Factory setting	Description
Creep Start	CrE	10 ... 170 %	50 %	Percentage of wire feed speed: 10 % slowed start, 170 % accelerated start
Post Current	PoC	-9 ... +9	0	Post current
Selection of Wire Feeder Address	Add	85 or 90	85	Bus address of wire feeder
Maximum Wire Feed Speed	FS	8 or 25 m/min	18 m/min	The max. wire feed speed selected; dependent on feed wheels
Disable PMT MIG guns	Gun	OFF or on	on	OFF = other gun ON = PMT gun
Restore Factory Settings	FAC	OFF or on	OFF	Restores factory settings when 'ON' is selected.

The parameter's value is immediately recorded in the memory. Exit SETUP mode by holding down the new SETUP button or by briefly pressing the ON/OFF button.

3.2. KWF 200 AND KWF 300 OPERATIONS

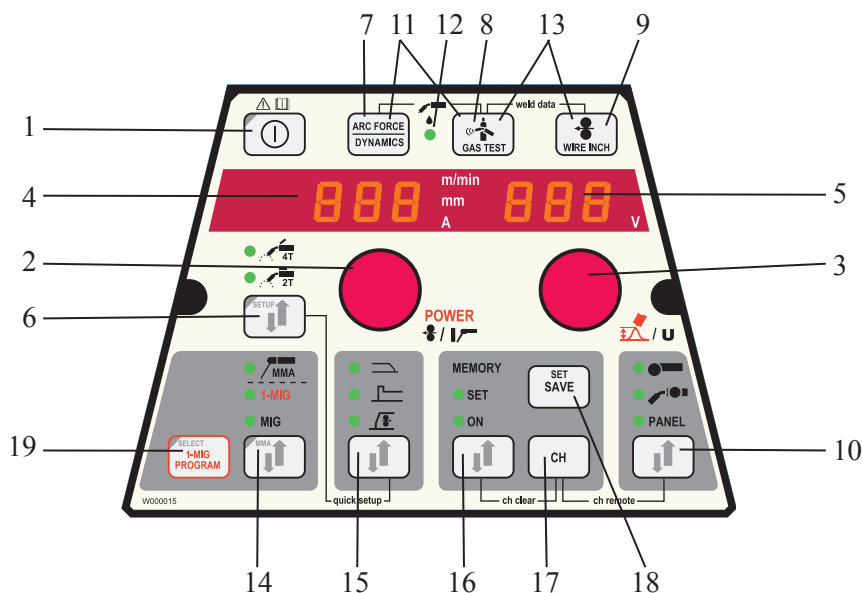

Main switch, ON/OFF (1)

The wire feed unit remains in the OFF position when the power source is switched ON, thus preventing start-up.

OFF is shown on the display.

When the ON/OFF button is pressed for more than 1 second, the unit starts up and all LEDs light up for a split second.

The unit is now ready for welding and will automatically return to previous position.

The unit starts up also by pressing three times shortly the start switch of the gun.

Basic settings and displays (2, 3, 4, 5)

With MIG welding, the wire feed speed is set via potentiometer No. 2, the value of which is shown on display No. 4. The welding voltage is set via potentiometer No. 3, the value of which is shown on display No. 5. During welding, display 4 shows the actual welding current value and display 5 shows the welding voltage.

With electrode welding (MMA), the welding current value is set via the potentiometer, the value of which is shown on display No. 4. Potentiometer 5 is not in use with electrode welding. Display 5 shows the idling voltage of the power source during adjustment of the value set for the current. During welding, display 4 shows the actual welding current value and display 5 shows the welding voltage.

When MIG dynamics/electrode welding Arc force adjustment is activated via button No. 7, the value is adjusted via potentiometer No. 3 (see the information on adjustment of MIG dynamics/arc force).

With Synergic 1-MIG welding, the power value is set via potentiometer 2 and the length of the arc via potentiometer 3 (see '1-MIG welding').

When the adjustment of SETUP parameters has been confirmed with 6 long button presses, the adjustable parameter is selected via potentiometer No. 2, the name of which is shown on display No. 4. The parameter's value is set via potentiometer No. 3, the value of which is shown on display No. 5 (see 'SETUP functions').

Selection of MIG operating procedure (6)

MIG 2T: MIG welding with two-sequence procedure of welding gun start switch

1. switch pressed: welding starts
2. switch released: welding stops

MIG 4T: MIG welding with four-sequence procedure of welding gun start switch

1. switch pressed: shielding gas flow starts
2. switch released: welding starts
3. switch pressed: welding stops
4. switch released: shielding gas flow stops

Adjustment of MIG dynamics/Arc Force (7)

With MIG welding dynamics adjustment is influenced on welding stability and spatter amount. Zero setting is recommended basic setting. Values \rightarrow min (-1...-9), softer arc for reduced spatter amount. Values \rightarrow max (1...9), harder arc for increased stability and when 100 % CO₂ shielding gas is used in welding of steel.

With electrode welding Arc Force adjustment is influenced on welding stability. Adjustment is needed for using different types of electrodes. Control range (-9...0) is commonly used for welding electrodes for stainless steel. Control range (0...+9) is used for harder arc characteristic to increase stability, e.g. for welding with thicker basic electrodes and using lower current value than recommended. Factory set value (0) is a good general use for adjusting the roughness of the arc.

Gas test (8)

The gas test button opens the gas valve without activating the wire feed or power source. Gas flows for 20 seconds by default. The display shows the remaining gas flow time. The default time of gas flow can be adjusted via the right-hand potentiometer within a range of 10 to 60 seconds. The new time setting is recorded in the memory. The gas flow can be discontinued by pressing the ON/OFF button or the start switch of the gun.

Wire feed test (9)

The wire feed switch starts the wire feed motor without opening the gas valve and without engaging the power source. The default wire feed speed is 5 m/min. The speed can be adjusted via the right-hand potentiometer. When the button is released, the wire feed stops. Operation returns to normal approx. 3 seconds after release of the button or if the ON/OFF button is pressed briefly.

Selection of liquid- /gas-cooled MIG gun (11)

Selection of liquid-cooled/gas-cooled MIG gun is activated by pressing buttons 7 and 8 simultaneously (for more than 1 second). When 'Gas' is shown on the display, the welding equipment will assume that a gas-cooled MIG gun has been connected. If the above buttons are pressed again, the text 'COO Ler' appears on the display and the LED (12) indicating liquid cooling selection lights up. In this case, the welding equipment will assume that a liquid-cooled MIG gun has been connected. When liquid cooling has been selected, the liquid cooling unit will start up in connection with the next equipment start-up.

Weld data (13)

The weld data function is activated by pressing buttons 8 and 9 simultaneously. The weld data function returns the welding current and voltage values to the displays that were in use when welding was discontinued.

Selection of welding process (14)

The welding process selection button is used to select either normal MIG welding, in which wire feed speed and welding voltage are adjusted separately, or Synergic 1-MIG welding, in which the wire feed speed, welding voltage, and related parameters are optimally bound to each other. In 1-MIG welding, the setting for power and arc length (see '1-MIG welding') are adjusted.

Electrode welding (MMA) is selected by pressing the button for >1 second. N.B.! When electrode welding is selected, the power source, the electrode holder connected to it and the MIG gun become energised (idling voltage).

Settings selection button (10)

The settings selection button is used to choose the basic settings required. Active settings are indicated by an LED pilot lamp. Settings are performed manually via the panel potentiometers or remotely via the remote control unit linked to the unit's remote-control connector. If settings are chosen to be performed via the gun controller connected to the welding gun, the wire feed speed / setting for power (1-MIG) will be adjusted via the gun controller and the welding voltage/arc length (1-MIG) adjusted via panel potentiometer No. 3.

N.B.! Remote control or gun settings can be chosen only if the controller in question is connected to the equipment, and in gun control the SETUP parameter 'GUN' is position "ON".

Additional MIG functions (15)

The selection button for additional MIG functions can be used to activate the slow start ('Creep Start'), hot start, or crater levelling ('Crater Level') function. Further presses of the selection button can select one or more of the above functions. N.B.! Only the available additional functions for each method can be selected.

Parameters related to these functions are set via the SETUP function (see 'SETUP functions').

The purpose of **Creep Start** is to facilitate the initial weld – e.g., when welding with a high wire feed speed. The wire feed speed is kept low until the wire touches the work piece and the current begins to flow. Creep Start can be selected with normal MIG welding or with Synergic 1-MIG welding.

The purpose of the **Hot Start** function is to reduce initial welding errors when welding highly heat-conductive materials such as aluminium. Hot Start can be selected when using Synergic 1-MIG welding and when the 4T operating mode is selected. In this case, when the start switch of the gun is held down, a fixed pre-gas time is displayed after which welding starts at the level determined by the SETUP mode's Hot Start parameter, returning to the normal level when the gun switch is released.

Stopping is performed as with the normal 4T function.

The purpose of **crater levelling** is to reduce welding defects caused by end cratering. The Crater Level function can be selected when using Synergic 1-MIG welding and when the 4T operating mode is selected.

When the gun switch is pressed down in connection with termination of welding, the welding power drops to the crater-filling level selected previously. The crater filling function is discontinued by releasing the gun switch.

The values of parameters related to additional MIG functions can be changed either with the **SETUP** function (see 'SETUP') or with the Quick SETUP function. Quick SETUP is activated by simultaneously pressing buttons 15 and 6. In this way, parameters related to MIG additional functions can be set.

Parameters are selected for adjustment either with button 15 or via potentiometer No. 2. The value of the parameter is set via potentiometer No. 3. The value is immediately recorded in the memory.

Name of parameter	Name on display	Parameter values	Factory setting	Description
Creep Start	CrE	10 ... 170 %	50 %	Percentage of wire feed speed: 10 % on hidastettu aloitus, 170 % on kiihdytetty aloitus
Hot Start	Hot	-50 ... +70 %	40 %	Prosenttia hitsaustehosta: -50 % slowed start, +70 % accelerated start
Crater Level	CrL	5 ... 99 %	50 %	Welding power end level, 5 % = minimum current, 99 % = maximum current

Memory functions (16, 17, 18)

Storage of settings

The memory functions can be used to record useful welding values in the memory. There are ten different memory locations: 0 ... 9.

In addition to welding values (wire feed speed, welding voltage), function options such as 2T/4T, Creep Start, and Crater Level are recorded in the memory.

Storage in memory is performed as follows:

1. Press the MEMORY button twice; the SET light begins to flash if the channel is not in use. If the channel is in use, the light remains lit. N.B.! If the memory is empty, press the MEMORY key once to get in SET mode.
2. Select the desired memory channel with the CH key.
3. Make the settings and store them in the memory by pressing the SAVE button.
4. Press the MEMORY key twice. Notice that the ON light is lit.
5. Begin welding.

If you wish to change some values, the light must be switched from the ON setting to the SET setting to enable you to select the required parameters. Press the SAVE button to complete the procedure. It is also possible to save the parameters of the current weld by pressing SET when the memory function is in OFF status (all lights off). The channel can be cleared by pressing MEMORY and the CH button simultaneously in SET mode.

Use of stored settings

1. Press the MEMORY button.
2. Select the memory channel via the CH button.
3. Begin welding.

The Ch remote function enables selection of memory channels via the selection controller located on the gun. The function is activated by pressing buttons 10 and 17 simultaneously. When the CH-remote is activated the light in remote control or in gun control starts to flash.

Synergic 1-MIG welding (14, 19)

In Synergic 1-MIG welding, the optimal welding parameters for the welding wires and gas used are recorded in the unit. The welding is controlled by adjusting the welding power and arc length.

Welding arc/programme selection:

Before commencing welding, a welding arc/programme suited to the welding wire and gas used must be chosen from the sticker glued to the inner surface of the KWF door.

Arc selection is activated by pressing button No. 19 for >1 second. In this case, displays 4 and 5 begin to flash and the material group is selected from the left-hand potentiometer and the welding arc/programme for the material group in question from the right potentiometer; see the enclosed table. (The table is also included on a sticker on the wire feed unit.)

SYNERGIC 1-MIG-Programs							
Prog	Wire Ø mm	Material	Gas mixture	Prog	Wire Ø mm	Material	Gas mixture
FF-group				SS-group continue...			
1	0,8	Fe	CO2	46	1,0	308/316	Ar+30 % He+1 % O ₂
2	0,9	Fe	CO2	47	1,2	308/316	Ar+30 % He+1 % O ₂
3	1,0	Fe	CO2	48	0,8	309	Ar+2 % CO ₂
4	1,2	Fe	CO2	49	0,9	309	Ar+2 % CO ₂
5	0,8	Fe	Ar+8 % CO ₂	50	1,0	309	Ar+2 % CO ₂
6	0,9	Fe	Ar+8 % CO ₂	51	1,2	309	Ar+2 % CO ₂
7	1,0	Fe	Ar+8 % CO ₂	52	0,8	309	Ar+30 % He+1 % O ₂
8	1,2	Fe	Ar+8 % CO ₂	53	0,9	309	Ar+30 % He+1 % O ₂
9	0,8	Fe	Ar+18 % CO ₂	54	1,0	309	Ar+30 % He+1 % O ₂
10	0,9	Fe	Ar+18 % CO ₂	55	1,2	309	Ar+30 % He+1 % O ₂
11	1,0	Fe	Ar+18 % CO ₂	56	0,9	308/316 FC	Ar+18 % CO ₂
12	1,2	Fe	Ar+18 % CO ₂	57	1,2	308/316 FC	Ar+18 % CO ₂
13	0,9	Fe MC	Ar+18 % CO ₂	58	0,9	309 FC	CO ₂
14	1,2	Fe MC	Ar+18 % CO ₂	59	1,2	309 FC	Ar+18 % CO ₂
15	1,2	Fe MC	CO ₂	60		Ss Special	
16	1,2	Fe FC Basic	Ar+18 % CO ₂	Al-group I			
17	1,2	Fe FC Rutile	Ar+18 % CO ₂	80	1,0	AlMg 5	Ar
18	1,2	Fe FC Rutile	CO ₂	81	1,2	AlMg 5	Ar
19		Fe-Special		82	1,0	AlSi 5	Ar
20		Fe-Special		83	1,2	AlSi 5	Ar
21		Fe-Special		84		Al-Special	
SS-group				SPE-group			
40	0,8	308/316	Ar+2 % CO ₂	90	1,0	CuSi 3	Ar
41	0,9	308/316	Ar+2 % CO ₂	91	1,2	CuSi 3	Ar
42	1,0	308/316	Ar+2 % CO ₂	92	1,0	CuAl 8	Ar
43	1,2	308/316	Ar+2 % CO ₂	93	1,2	CuAl 8	Ar
44	0,8	308/316	Ar+30 % He+1 % O ₂	94		Special	
45	0,9	308/316	Ar+30 % He+1 % O ₂				

W000143

The selected programme is immediately recorded in the memory. To get back to normal status press ON/OFF (1) key, or 1-MIG-PROGRAM button (19).

Use of a selected welding arc/programme:

Select the relevant welding process with the 1-MIG selection button (14). Check that the welding arc/programme corresponds to the welding wire and shield gas in use. The check is performed by briefly pressing the 1-MIG-PROGRAM button (19), after which the displays show the material group and the programme number. Consult the above-mentioned table for the wire type and gas that correspond with the programme number.

Set the desired welding power via potentiometer 2 and the arc length via potentiometer 3.

SETUP functions (6)

The unit is equipped with a number of additional functions that can be selected. Parameters can be set via the SETUP function. The SETUP function is activated by pressing the SETUP button (6) for >1 second. The adjustable parameter is selected via the left-hand potentiometer (2), the name of which is shown on display No. 4. The value of the parameter in question is adjusted via the right-hand potentiometer (3), the value of which is shown on the display (5). The parameters and their possible values are:

Name of parameter	Name on display	Parameter values	Factory setting	Description
Creep Start	CrE	10 ... 170 %	50 %	Percentage of wire feed speed: 10 % slowed start 170 % accelerated start
Hot Start	Hot	-50 ... +70 %	40 %	Percentage of welding power: -50 % cold and +70 % hot
Crater Level	CrL	5 ... 99%	50 %	End level of welding power, 5 % = minimum current, 99 % = maximum current
Post Current	PoC	-9... +9	0	Post current
Calibration Voltage	CAL	-5,0 ... 9,0 V	0,0 V	Compensation (1-MIG)
1-MIG Unit mm, m/min	Unl	m/min or mm or A	m/min	In 1-MIG welding, parameter unit shown in left-hand display/ Average current
Selection of Wire Feeder Address	Add	85 or 90	85	Wire feeder address
Maximum Wire Feed Speed	FS	18 or 25 m/min	18 m/min	The max. wire feed speed selected; dependent on feed wheels
Disable PMT MIG guns	Gun	OFF or ON	ON	OFF = other gun ON = PMT gun
Restore Factory Settings SETUP-	FAC	OFF or ON	OFF	Restores factory settings when 'on' is selected, exit SETUP mode

The value of the parameter is immediately recorded in the memory. Exit SETUP mode by holding down the new SETUP button or by briefly pressing the ON/OFF button.

4. OPERATIONS OF REMOTE CONTROL UNITS IN KWF WIRE FEED UNIT

R20

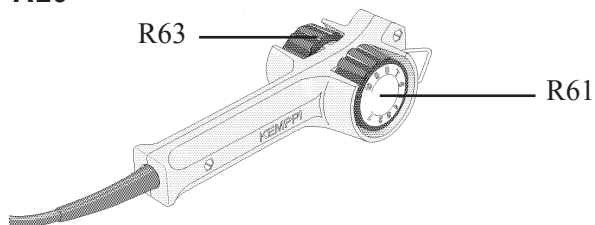

	R63	R61
MIG	Setting for wire feed: I 1...18 m/min II 1...25 m/min	Setting for voltage: 10 V...max. voltage of power source (35...46 V)
MEMORY	Channel selection: 1...5 corresponding to settings 1, 4, 6, 8, 10 of knob	Fine adjustment for arc length: 1...10
SYNERGIC MIG	Setting for power (wire feed speed): according to wire min. ... max.	Fine adjustment for arc length: 1...10
MMA	Setting for power: 10 A...max. power of power source	NO OPERATION

R10, RMT10

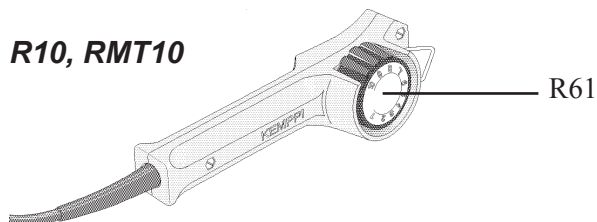

	R61	RMT10 remote control unit for PMT/WS gun
MIG	Setting for wire feed: I 1...18 m/min II 1...25 m/min	Setting for wire feed: I 1...18 m/min II 1...25 m/min
MEMORY	Channel selection: 1...5 corresponds in the R10 settings 1, 4, 6, 8, 10 of knob	Channel selection 1...5
SYNERGIC MIG	Setting for power (wire feed speed): according to wire min. ... max.	Setting for power (wire feed speed) according to wire min. ... max. (see page 18, part 10)
MMA	Setting for power: 10 A...max. power of power source	NOTE! RMT10 NO OPERATION

5. WELDFORCE ERROR CODES

The existence of possible faults in the equipment is investigated in connection with each wire feed unit start-up. If a fault is detected, the fault in question will be indicated as an 'Err' message on the (Is) panel display (see enclosed illustration).

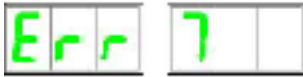

Error code examples:

Err 1: Not in use.

Err 2:

Press the start switch of the gun when data transfer between KWF and KPS has been disrupted (control cable fault or connector fault).

Err 4:

Press the start switch of the gun when liquid cooling has been selected via the KWF user interface as the gun-cooling method and the KWU cooling unit has failed to be connected.

Err 5:

The KWU cooling unit has interrupted welding. Possible causes: loss of supply voltage from KWU, failure of fluid circulation pressure to rise, or an excessive increase in coolant temperature.

Err 6: Not in use.

Err 7: Not in use.

Err 8:

Overheating of liquid-cooled PMT or WS™ gun.

Err 9:

Overloading of the wire feed motor, caused by, e.g., clogging of the gun wire conduit or excessive bending of the gun cable.

Err 10:

Welding disrupted by activation of thermal protection of KPS power source.

Err 11:

An attempt has been made to use a PMT or WS™ gun when its use is prevented by the SETUP function.

Err 12:

Welding disrupted due to activation of the gas guard (functions require additional attachments to the standard unit).

Err 13: Not in use.

Err 14: Not in use.

Resetting error codes:

Error codes Err 2-4 automatically disappears within 5 seconds if the trigger is not pressed.

The cause of the error must be eliminated before the next start-up.

Error codes Err 5-14 disappears on the next start-up if the source of the error has been removed.

6. SERVICE, OPERATION DISTURBANCES

The amount of use and the working environment should be taken into consideration when planning the frequency of maintenance of KWF. Careful use and preventive maintenance will help to ensure trouble-free operation.

The following maintenance operations should be carried out at least every six months:

Check:

- The wear of the grooves of the feed rolls. Excessive wear of grooves causes problems in wire feed.
- The wear of the wire guide tubes of wire feed. Badly worn feed rolls and wire guide tubes should be discarded.
- The wire guide tube in the gun should be set as near the feed rolls as possible, but not touching them and the wire must follow a straight line from the end of the tube to the groove of the feed roll.
- Reel brake adjustment.
- Electric connections
 - * Oxidised couplings must be cleaned
 - * Loose couplings must be tightened

Clean dust and dirt from the equipment.

 **When using compressed air, always protect your eyes with proper eye protection.**

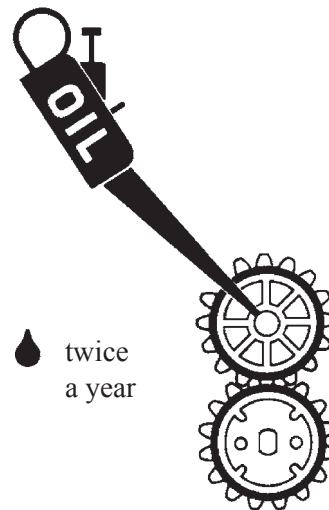

In case of problems contact your KEMPPI dealer.

7. DISPOSAL OF THE MACHINE



Do not dispose of electrical equipment together with normal waste!

In observance of European Directive 2002/96/EC on Waste Electrical and Electronic Equipment and its implementation in accordance with national law, electrical equipment that has reached the end of its life must be collected separately and returned to an environmentally compatible recycling facility. As the owner of the equipment, you should get information on approved collection systems from our local representative.

By applying this European Directive you will improve the environment and human health!

8. ORDERING NUMBERS

KWF200		6232200
KWF200S		6232200S
KWF300		6232300
KWF300S		6232300S
KPS 3500	3 ph 400V	6131350
KPS 4500	3 ph 400V	6131450
KPS 5500	3 ph 400V	6131550
KPS 3500MVU	3 ph 230 / 400V	613135003
KPS 4500MVU	3 ph 230 / 400V	613145003
KPS 5500MVU	3 ph 230 / 400V	613155003
KWU10		6262110
Transport unit T 400		6185267
Transport unit P40		6185264
KWF300/300SP500		6185265
KV 400		6185247

Accessories

KWF 200 hanging frame (incl. KPS mounting set)		6185285
KWF 200 protection slides (incl. KPS mounting set)		6185286
KWF 300 protection slides		6185287
KWF 200/300 spool space heater		6185288
KWF Sync 300		6263300
GG 200/300 Gas Guard		6237406

Remote control units

R10	5 m	6185409
R10	10 m	618540901
R 20	5 m	6185419
RMT 10 (for PMT MIG-gun)		6185475

MIG-guns

PMT 27	3 m	6252713
PMT 27	4.5 m	6252714
PMT 32	3 m	6253213
PMT 32	4.5 m	6253214
PMT 35	3 m	6253513
PMT 35	4,5 m	6263514
PMT 42	3 m	6254213
PMT 42	4,5 m	6254214
PMT 50	3 m	6255013
PMT 50	4,5 m	6255014
MMT 32	3 m	6253213MMT
MMT 32	4,5 m	6253214MMT
MMT 35	3 m	6253513MMT
MMT 35	4,5 m	6253514MMT
MMT 42	3 m	6254213MMT
MMT 42	4,5 m	6254214MMT

PMT 30W	3 m	6253043
PMT 30W	4,5 m	6253044
PMT 42W	3 m	6254203
PMT 42W	4,5 m	6254204
PMT 52W	3 m	6255203
PMT 52W	4,5 m	6255204
MMT 30W	3 m	6253043MMT
MMT 30W	4,5 m	6253044MMT
MMT 42W	3 m	6254203MMT
MMT 42W	4,5 m	6254204MMT
MMT 52W	3 m	6255203MMT
MMT 52W	4,5 m	6255204MMT

Interconnecting cables

KWF 70-1,8-GH		6260401
KWF 70-1,8-WH		6260403
KWF 70-5-GH		6260405
KWF 70-5-WH		6260407
PROMIG 2/3 70-10-GH		6260326
PROMIG 2/3 70-10-WH		6260334

9. TECHNICAL DATA

		<i>KWF 200/200S</i>	<i>KWF 300/300S</i>
Working voltage (safety voltage)		50 VDC	50 VDC
Rated power		100 W	100 W
Max. load (nominal values)			
	60 % ED	520 A	520 A
	100 % ED	440 A	440 A
Operation principle		4-roll feed	4-roll feed
Diameter of feed roll		32 mm	32 mm
Wire feed speed I		0...18 m/min	0...18 m/min
Wire feed speed II ¹⁾		0...25 m/min	0...25 m/min
Filler wires			
	∅ Fe, Ss	0,6...1.6	0,6...2,4
	∅ Cored wire	0,8...1.6	0,8...2,4
	∅ Al	1,0...1.6	1,0...2,4
Wire reel			
	max. weight	5 kg	20 kg
	max. size	∅ 200 mm	∅ 300 mm
Gun connector		Euro	Euro
Operation temperature range		-20...+40 °C	-20...+40 °C
Storage temperature range		-40...+60 °C	-40...+60 °C
Degree of protection		IP 23 C	IP 23 C
Dimensions			
	length	510 mm	590 mm
	width	200 mm	240 mm
	height	310 mm	445 mm
Weight		9.4 kg	13.6 kg

The products meet conformity requirements for CE marking.

¹⁾ Changes of speed are carried out by changing gear wheel

10. TERMS OF GUARANTEE

Kemppi Oy provides a guarantee for products manufactured and sold by them if defects in manufacture and materials occur. Guarantee repairs must be carried out only by an Authorised Kemppi Service Agent. Packing, freight and insurance costs to be paid by orderer. The guarantee is effected on the date of purchase. Verbal promises which do not comply with the terms of guarantee are not binding on guarantor.

Limitations on guarantee

The following conditions are not covered under the terms of guarantee: defects due to natural wear and tear, non-compliance with operating and maintenance instructions, connection to incorrect or faulty supply voltage (including voltage surges outside equipment spec.), incorrect gas pressure, overloading, transport or storage damage, fire or damage due to natural causes i.e. lightning or flooding.

This guarantee does not cover direct or indirect travelling costs, daily allowances or accommodation.

Note: Under the terms of guarantee, welding torches and their consumables, feeder drive rolls and feeder guide tubes are not covered. Direct or indirect damage due to a defective product is not covered under the guarantee. The guarantee is void if changes are made to the product without approval of the manufacturer, or if repairs are carried out using non-approved spare parts.

The guarantee is also void if repairs are carried out by non-authorized agents.

Undertaking guarantee repairs

Guarantee defects must be informed to Kemppi or authorised Kemppi Service Agents within the guarantee period. Before any guarantee work is undertaken, the customer must provide proof of guarantee or proof of purchase, and serial number of the equipment in order to validate the guarantee.

The parts replaced under the terms of guarantee remain the property of Kemppi.

Following the guarantee repair, the guarantee of the machine or equipment, repaired or replaced, will be continued to the end of the original guarantee period.

KEMPPI OY
PL 13
FIN – 15801 LAHTI
FINLAND
Tel (03) 899 11
Telefax (03) 899 428
www.kemppi.com

KEMPPIKONEET OY
PL 13
FIN – 15801 LAHTI
FINLAND
Tel (03) 899 11
Telefax (03) 7348 398
e-mail: myynti.fi@kemppi.com

KEMPPI SVERIGE AB
Box 717
S – 194 27 UPPLANDS VÄSBY
SVERIGE
Tel (08) 590 783 00
Telefax (08) 590 823 94
e-mail: sales.se@kemppi.com

KEMPPI NORGE A/S
Postboks 2151, Postterminalen
N – 3103 TØNSBERG
NORGE
Tel 33 34 60 00
Telefax 33 34 60 10
e-mail: sales.no@kemppi.com

KEMPPI DANMARK A/S
Literbuen 11
DK – 2740 SKOVLUNDE
DANMARK
Tel 44 941 677
Telefax 44 941 536
e-mail:sales.dk@kemppi.com

KEMPPI BENELUX B.V.
Postbus 5603
NL – 4801 EA BREDA
NEDERLAND
Tel +31 (0)76-5717750
Telefax +31 (0)76-5716345
e-mail: sales.nl@kemppi.com

KEMPPI (UK) Ltd
Martti Kemppi Building
Fraser Road
Priory Business Park
BEDFORD, MK443WH
ENGLAND
Tel 0845 6444201
Fax 0845 6444202
e-mail: sales.uk@kemppi.com

KEMPPI FRANCE S.A.
65 Avenue de la Couronne des Prés
78681 EPONE CEDEX
FRANCE
Tel (01) 30 90 04 40
Telefax (01) 30 90 04 45
e-mail: sales.fr@kemppi.com

KEMPPI GmbH
Otto – Hahn – Straße 14
D – 35510 BUTZBACH
DEUTSCHLAND
Tel (06033) 88 020
Telefax (06033) 72 528
e-mail:sales.de@kemppi.com

KEMPPI SP. z o.o.
Ul. Piłsudskiego 2
05-091 ZĄBKI
Poland
Tel +48 22 781 6162
Telefax +48 22 781 6505
e-mail: info.pl@kemppi.com

KEMPPI WELDING
MACHINES AUSTRALIA PTY LTD
P.O. Box 404 (2/58 Lancaster Street)
Ingleburn NSW 2565, Australia
Tel. +61-2-9605 9500
Telefax +61-2-9605 5999
e-mail: info.au@kemppi.com