

DIGITAL CONNECTIVITY MODULE (DCM)

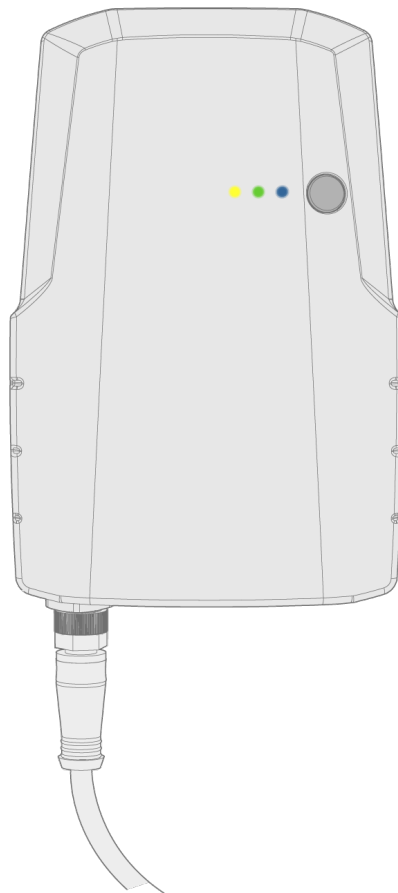

Operating manual

CONTENTS

1. General	3
1.1 Equipment description	5
2. Installation	7
2.1 Mounting on equipment	8
2.2 Connecting cables	11
2.3 Installing WeldEye App	12
2.4 Android operating system settings	15
3. Operation	16
3.1 Pairing with mobile device	17
3.2 Settings	18
3.3 Using WeldEye App	21
3.4 During welding	28
3.5 Completing welding tasks with WeldEye App	29
3.6 Synchronizing welding data	30
3.7 Resetting	31
3.8 Disconnecting	32
3.9 Updating DCM	33
4. Technical data	34
5. Ordering codes	35

1. GENERAL

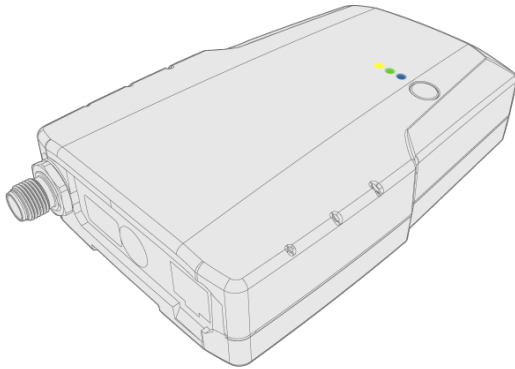

Kempppi's Digital Connectivity Module (DCM) is a small single-board computer connected directly to the welding power source or wire feeder. Together with WeldEye App, it collects and synchronizes welding data and adds tools to the workflow management, for example, in the form of work orders and welding procedure specifications (WPS). The welding data collected with DCM is synchronized with the WeldEye welding management software cloud via WeldEye App.

DCM communicates wirelessly with the mobile device.

DCM and WeldEye App are a new alternative for Kempppi's Smart Reader device. It is compatible with the following Kempppi welding equipment:

- Master M 353, 355, 358
- X5 FastMig
- FastMig KMS
- FastMig Pulse
- FastMig M
- FastMig X
- Kemparc
- Kemparc Pulse
- A7 MIG Welder
- MasterTig 235ACDC
- MasterTig 325DC
- MasterTig 335ACDC
- MasterTig 425DC
- MasterTig 535ACDC.

DCM also supports non-Kempppi welding equipment through ARC Euro Adapter -CV, ARC Saw Adapter and ARC Universal Adapter -CV/-TIG.

Important notes

Read the instructions through carefully. For your own safety, and that of your working environment, pay particular attention to the safety instructions delivered with the equipment.

Items in the manual that require particular attention in order to minimize damage and harm are indicated with the below symbols. Read these sections carefully and follow their instructions.

 *Note: Gives the user a useful piece of information.*

 *Caution: Describes a situation that may result in damage to the equipment or system.*

 *Warning: Describes a potentially dangerous situation. If not avoided, it will result in personal damage or fatal injury.*

DISCLAIMER

While every effort has been made to ensure that the information contained in this guide is accurate and complete, no liability can be accepted for any errors or omissions. Kempfi reserves the right to change the specification of the product described at any time without prior notice. Do not copy, record, reproduce or transmit the contents of this guide without prior permission from Kempfi.

1.1 Equipment description

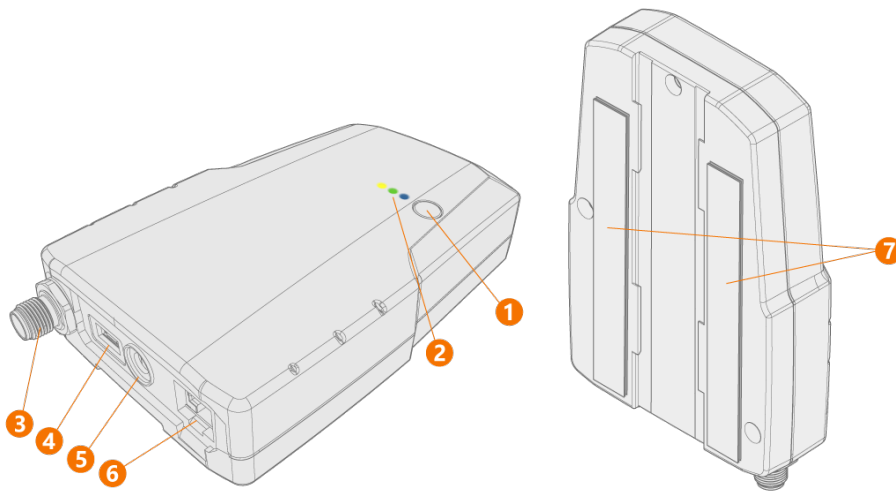

1. Function button
2. 3 LED indicators
3. CAN connection (5-pin, M12 bus connector)



4. USB connector *



5. Power connector *



6. Ethernet connector *



7. Mounting tape.

* Not needed for normal operation. DCM is powered through the CAN connection.

LEDs explained



- a. Red / yellow / green: Additional notification light. (A)
- b. Green: Lit when the power is on. (B)
- c. Blue: Blinks infrequently when ready and available, blinks more frequently when in "beacon mode", is lit continuously when a mobile device with the WeldEye App is connected. (C)

Additional requirements

- Mobile device with wireless connection functions running Android 6.0 (or newer) and WeldEye App
- Internet connection available for the mobile device running WeldEye App
- Kemppi's WeldEye welding management software account.

EQUIPMENT IDENTIFICATION

Serial number

Serial number of the device is marked on the rating plate or in another distinctive location on the device.

Quick Response (QR) code

The serial number and other device-related identification information may also be saved in the form of a QR code (or a barcode) on the device. Such code can be read by a smartphone camera or with a dedicated code reader device providing fast access to the device-specific information.

2. INSTALLATION

 *Do not power on the equipment before the installation is complete.*

"Mounting on equipment" on the next page

"Connecting cables" on page 11

"Installing WeldEye App" on page 12

"Android operating system settings" on page 15

Before installation

Check the contents of the packages and make sure the parts are not damaged.

2.1 Mounting on equipment

The DCM device can be fixed on the side of a power source or a wire feeder either with the factory-fitted mounting tape or with an optional DIN rail.

The mounting tape can be used on any clean and suitable surface. The mounting tape counterparts are attached together on delivery.

 *Do not detach the mounting tape counterpart from the DCM device before fixing. This way the mounting tape counterparts are positioned correctly on the installation surface.*

 *Install the DCM device the connectors facing down. This also prevents e.g. dust and impurities from getting into the connectors.*

Fixing with mounting tape

1. Clean the installation surface (where the DCM device is to be fixed).
2. Remove the cover wrappings from the mounting tape counterpart to reveal the adhesive surface. Leave the mounting tape counterparts still attached.

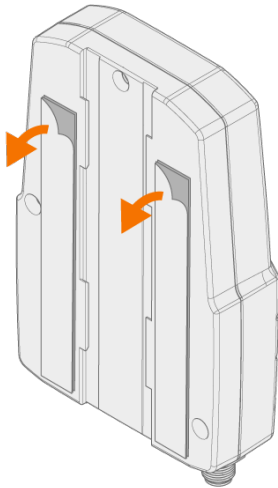

3. Press the DCM device firmly against the installation surface so that the glue sticks.

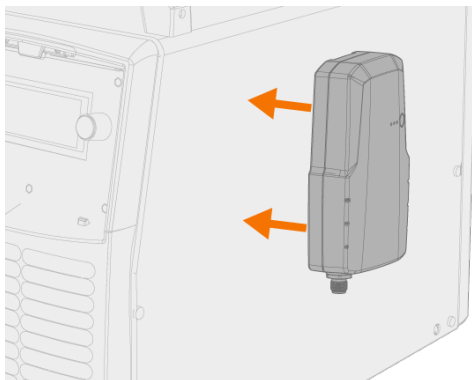

4. Let the mounting tape's adhesive cure for 30 minutes.

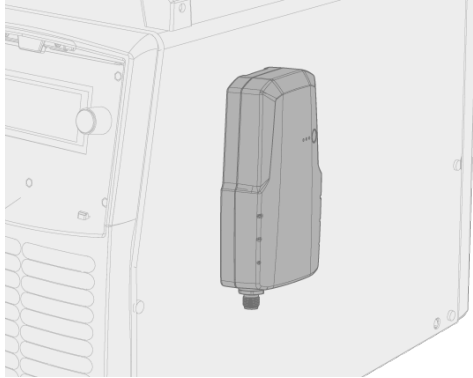

5. Due to the velcro-type mounting tapes, it is now possible to detach and attach the DCM device if needed.

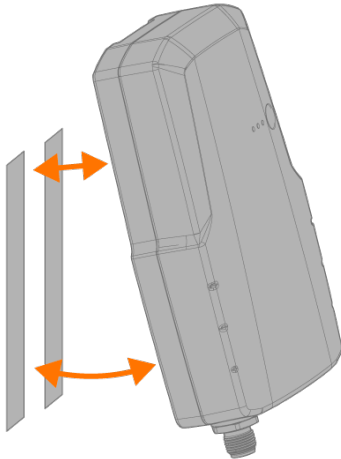

Mounting on DIN rail (optional)

 Note that the rail installation typically requires drilling fixing holes on the fixing surface for the rail itself. This is not covered by this instruction.

The rear of the DCM box has a groove for the standard DIN rail fixing:

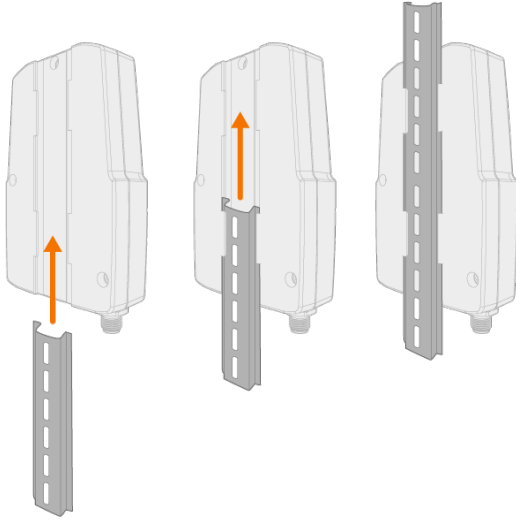

2.2 Connecting cables

For normal operation, the DCM box requires only the CAN cable to be connected.

i *Unused DCM connectors are covered. Leave the covers in place.*

1. Connect the CAN cable to the power source or to the wire feeder.
2. Connect the other end of the CAN cable to the DCM box. Secure the cable by turning the cable coupling firmly on the connector threads.

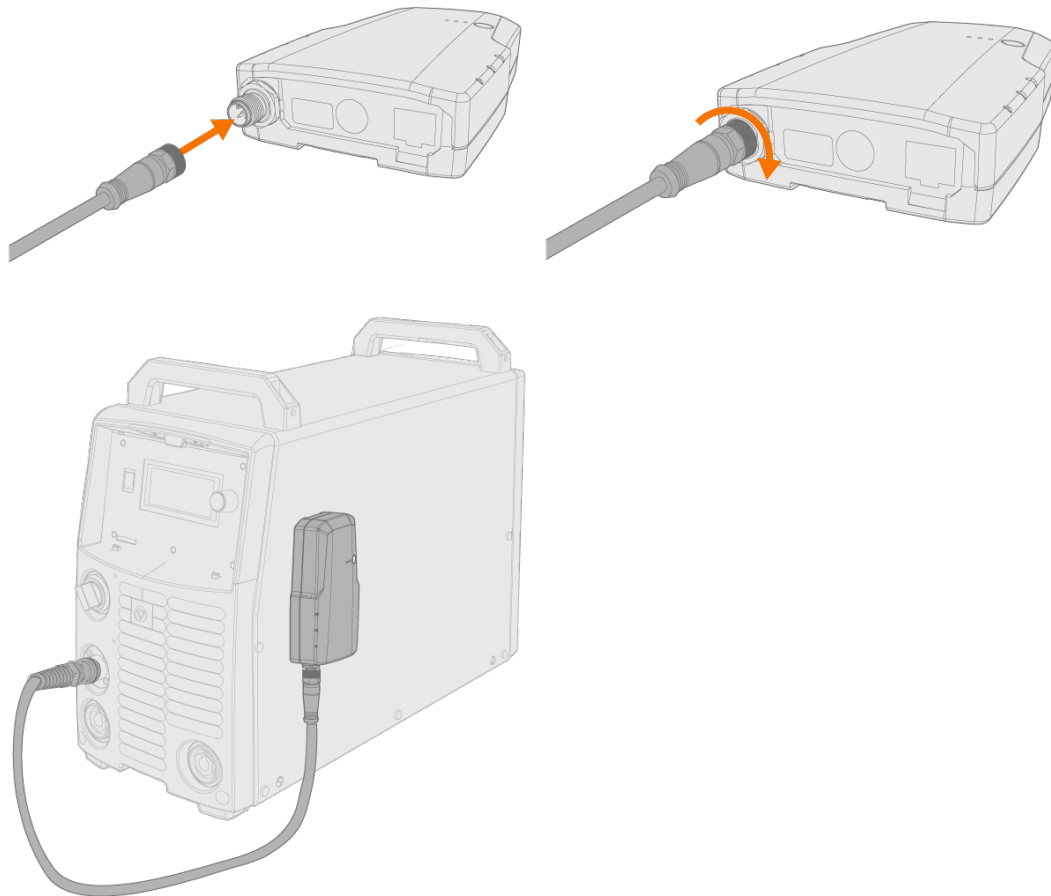

2.3 Installing WeldEye App

 You must have Kemppi's WeldEye welding management software account already in use before signing into WeldEye App on a mobile device.

1. Scan the QR code below or search for 'WeldEye App' in Google's Play Store.



2. Install the application.
3. Open the application and sign in.

Signing in with WeldEye credentials:

>> Select **Sign in**.

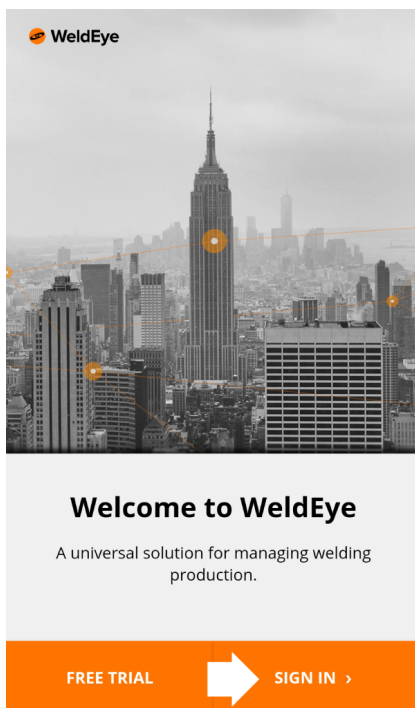

>> Select **Log in manually with email and password**.

>> Enter the email address and password associated with your WeldEye account.

Logging in using a QR code:

>> On a computer, sign in to your WeldEye welding management software cloud.

>> In your WeldEye welding management software, browse to 'Administration > Machine fleet'. In the 'Mobile devices' tab, select **Register a new device**.

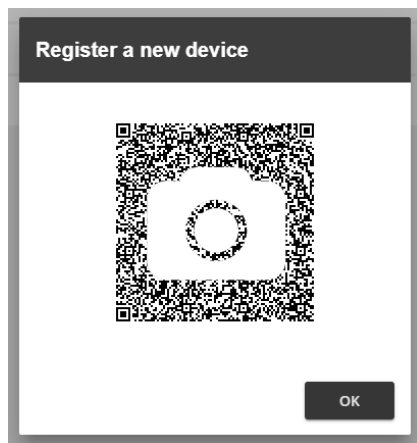
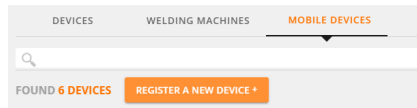
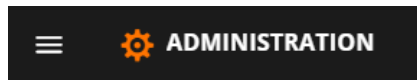

>> In the WeldEye App, select **Scan QR code** and aim the mobile device's camera at the QR code on the computer screen.

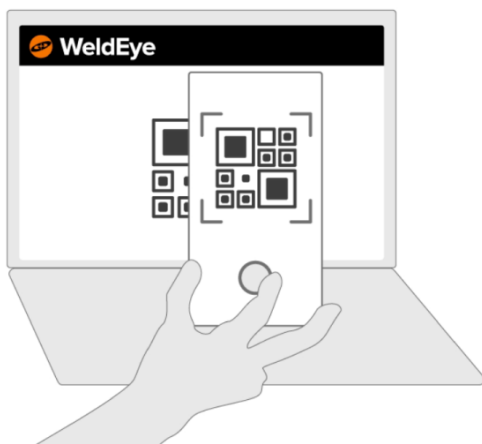

Once the login process is completed, the mobile device as well as the welding equipment connected to the WeldEye App are associated with your organization in the WeldEye welding management software.



With some Android mobile device models it is necessary to disable the Android operating system's power saving and optimizing features for the WeldEye application. Otherwise the operating system may shut down the WeldEye App processes on the mobile device and therefore prevent welding data transmission. See "Android operating system settings" on the next page for more instructions.

2.4 Android operating system settings

To prevent the Android operating system's battery saving and optimizing features from automatically shutting down WeldEye App, please do the following:

 Due to the vast amount of Android mobile device makes and models, these instructions are only for generic reference. For a specific Android device model, please refer to the device manufacturer's instructions.

1. Access your Android mobile device's settings and go to **Apps**.
2. Select the WeldEye application on the list.
3. Go to the **Battery** settings.
4. Go to the **Optimize battery usage** settings.
5. Disable the battery optimization options for the WeldEye application.

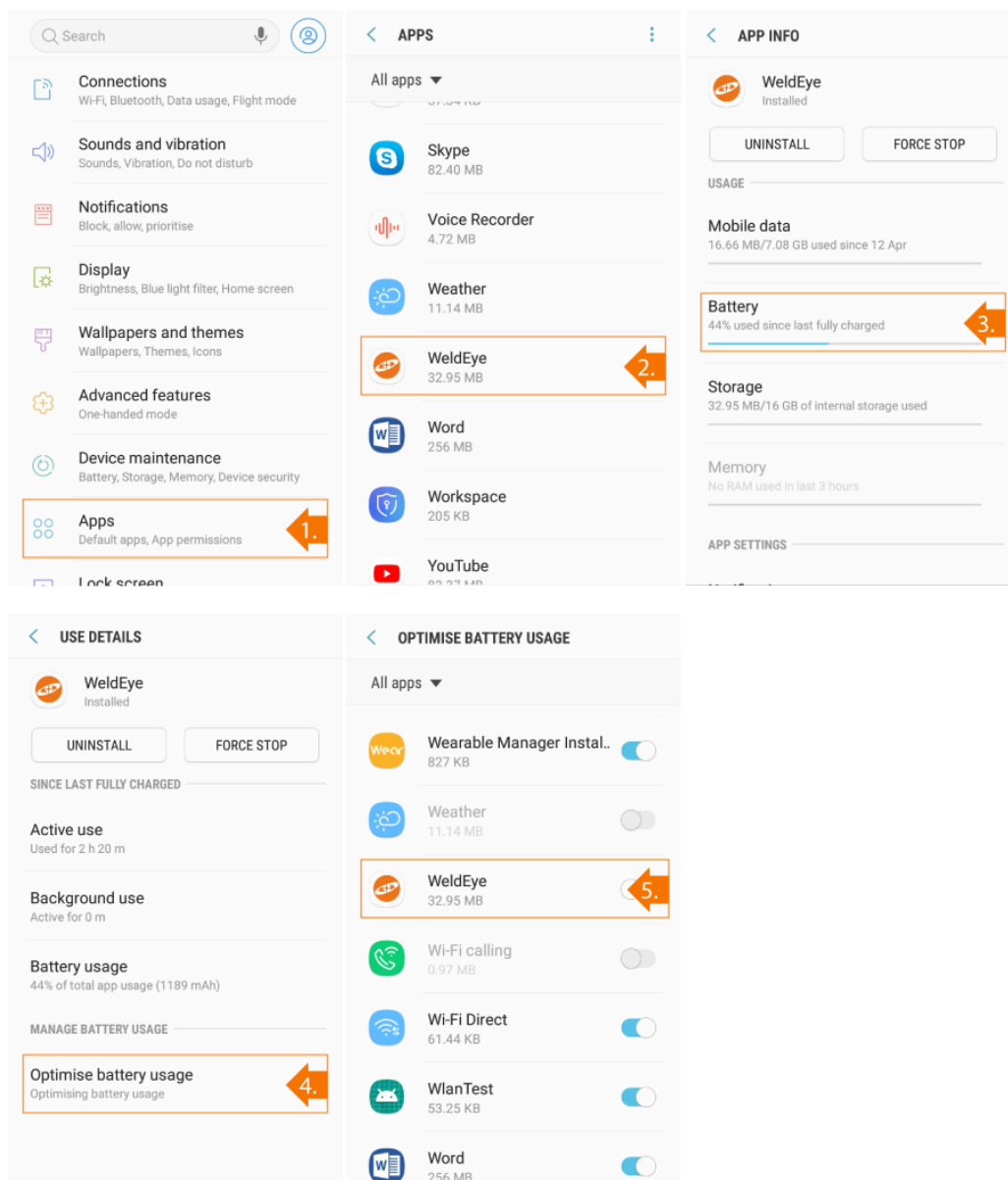

3. OPERATION

"Pairing with mobile device" on the next page

"Settings" on page 18

"Using WeldEye App" on page 21

"During welding" on page 28

"Completing welding tasks with WeldEye App" on page 29

"Synchronizing welding data" on page 30

"Resetting" on page 31

"Disconnecting" on page 32

3.1 Pairing with mobile device

In order to activate the DCM device and to access the welding data collected by the DCM device, a mobile device running the WeldEye App must be connected wirelessly to the DCM device.

1. Ensure that the green LED is lit and that the blue LED blinks infrequently on the DCM box.
2. Open the WeldEye App on your mobile device and select **Click to connect**. WeldEye App automatically starts searching available DCM devices.

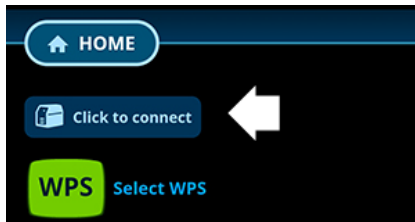

3. On the list, select the DCM and welding equipment you wish to connect to.

If there are several DCM boxes available to choose from and you are uncertain which is which, you can press the function button on the DCM box briefly (1 sec.) to turn on its wireless beacon. A blue indicator is shown next to the device in question.

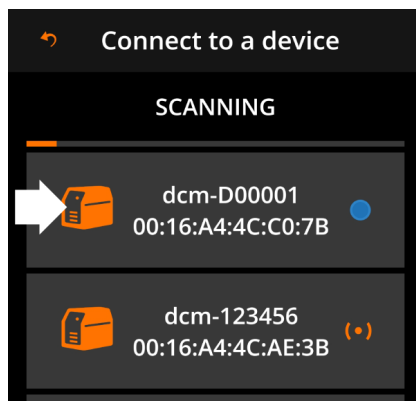

Once the connection is made, the blue LED on the DCM box is lit continuously. Notice that only one mobile device can be connected to the DCM at a time.

3.2 Settings

The "Cable compensation" below and "Diagnostics" on the next page settings in the WeldEye App can be accessed by clicking the settings icon at the top of the home view.



Cable compensation

1. Click **EDIT** to access the cable compensation adjustment.

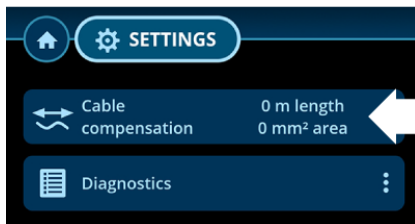

2. Select a value for adjusting by clicking on the corresponding row.

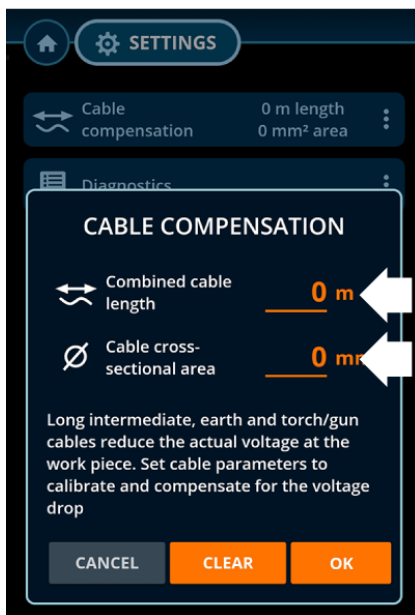

3. Enter the value.

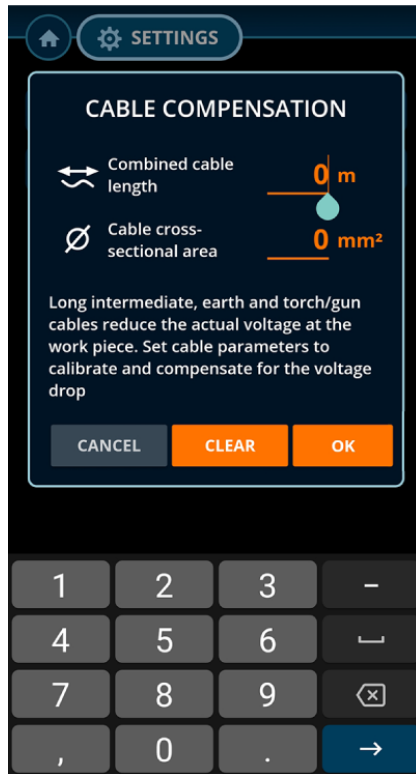

4. Repeat with the other adjustment value.
5. When ready, click **OK**.

Diagnostics

This settings view includes information on application version, connected organization, device information, used network connection and available memory, for example.

In the diagnostics view you can also select the log level – INFO for basic information and DEBUG for collecting all information available – and export log files.

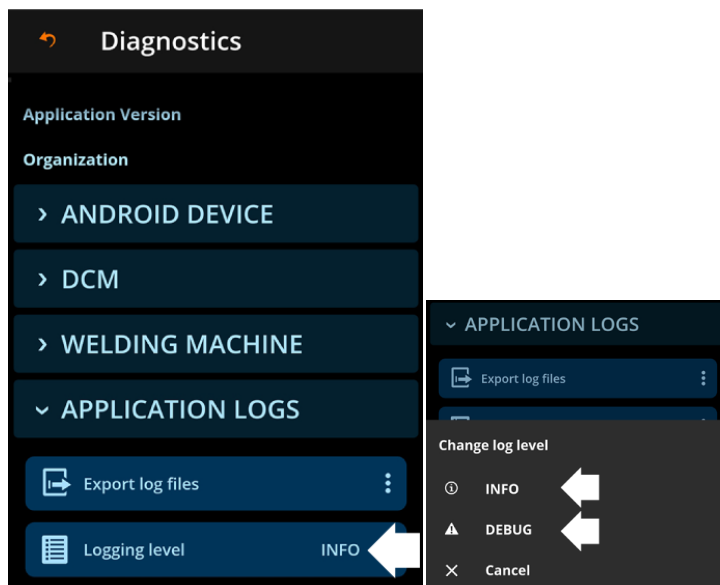

To export log files:

>> Select **Export log files**.

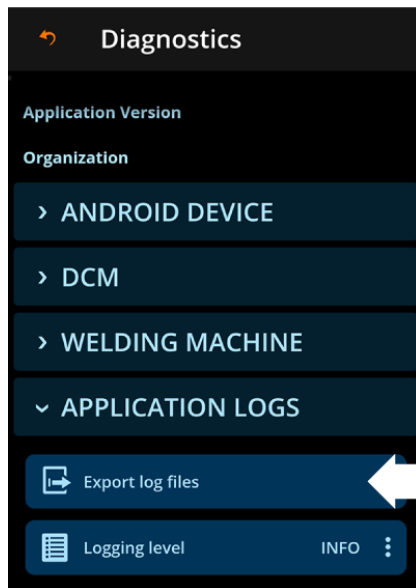

>> Once WeldEye App has finished sending the log information, the log's ID string is shown for later reference.

>> Select **Close** to exit the log export dialog.

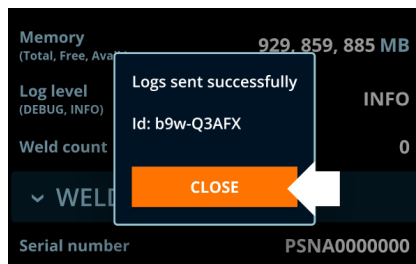

3.3 Using WeldEye App

- "Selecting user (welder)" below
- "Selecting reason code" below
- "Selecting work order" on the next page
- "Selecting Welding Procedure Specification (WPS)" on page 24.
- "Selecting filler material" on page 26
- "Selecting shielding gas" on page 27

Selecting user (welder)

1. Click the welder icon.

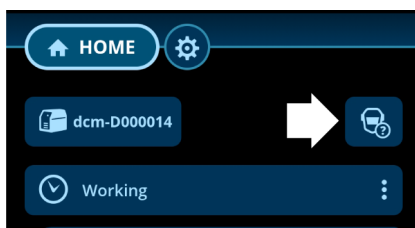

2. Select the user (welder) on the list.

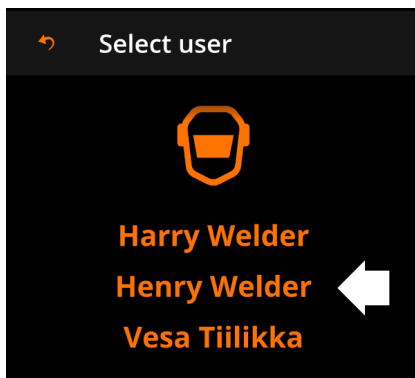

Selecting reason code

By default, WeldEye App uses 'Working' as a reason code to describe the current status. With this selection, it is also possible to report breaks etc., as applicable.

1. Click the reason code row.

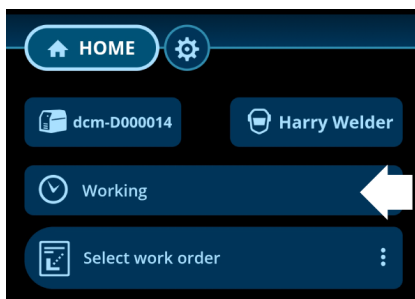

2. Select a reason code best suited for the current situation.

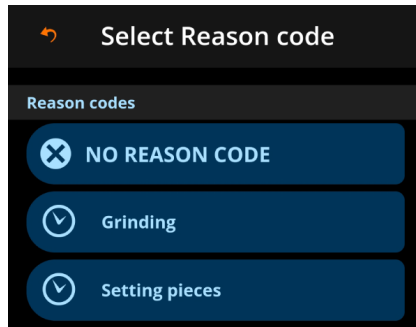

-  *The selected reason code is applied immediately once selected and a time counter is started. **No reason code** returns the status to 'Working'.*

Selecting work order

1. Click **Select work order**.

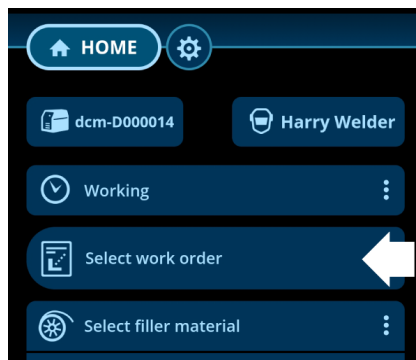

2. Search and/or choose a work order on the work order list.

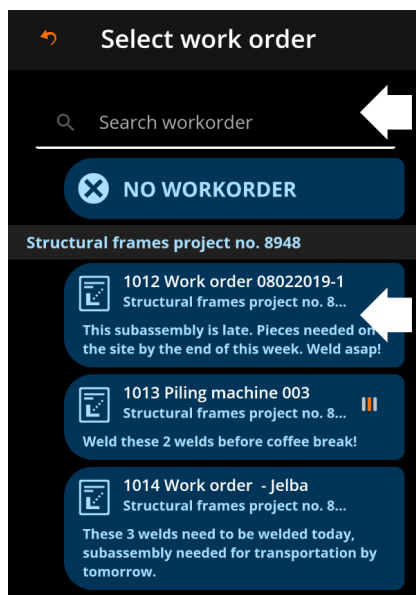

3. Choose a weld on the work order or click **Select work order** to continue without selecting a specific weld. If a Welding Procedure Specification (WPS) is saved for the selected weld, the WPS is automatically activated.

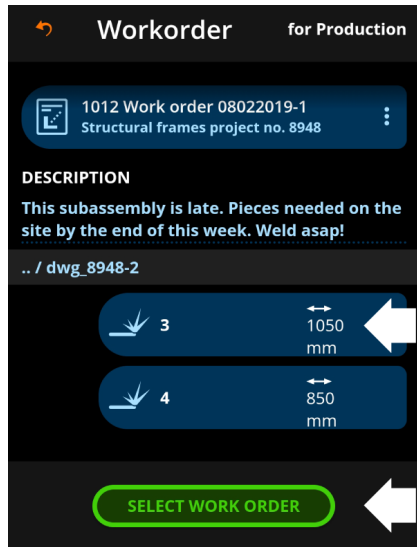

Selecting Welding Procedure Specification (WPS)

i It is advisable to select the Welding Procedure Specification (WPS) before choosing the filler wire and/or the shielding gas used. Recommendations for both are then sourced from the WPS.

1. Click the WPS icon.



2. As necessary, filter the available WPSes on the list based on welded material, material thickness, joint type or welding process, for example. Sort the items in alphabetical order or based on the date.

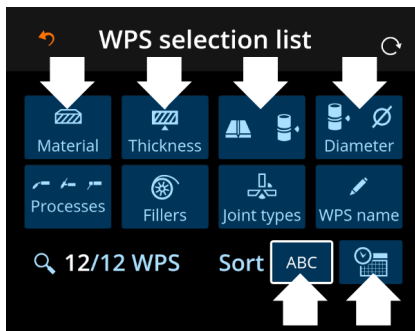

3. Click on a WPS to see its details and to select it.

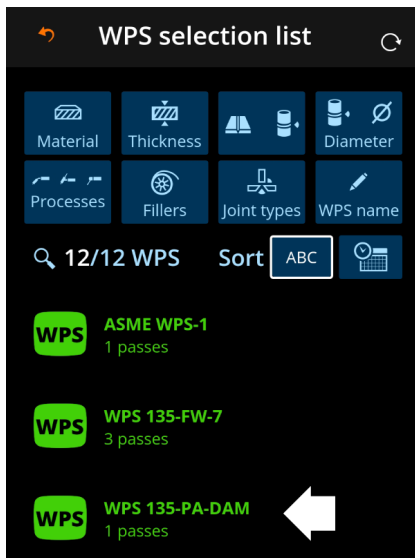

4. Select the WPS by clicking **Select WPS**.

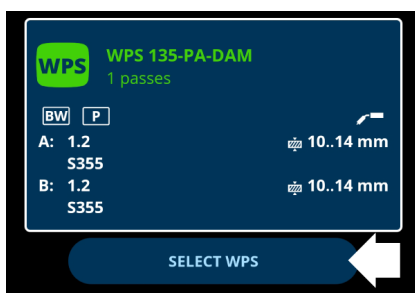

The basic information of the selected WPS is also shown in the home view. For more detailed WPS information, click the info (i) symbol on the right.

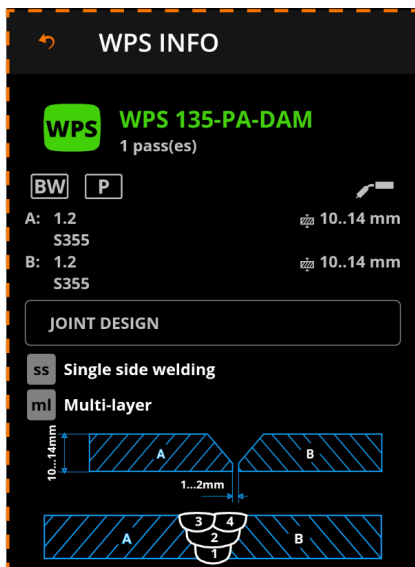
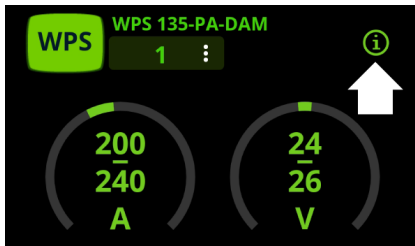

The weld pass in the selected WPS can be changed by clicking the WPS pass number in the home view.

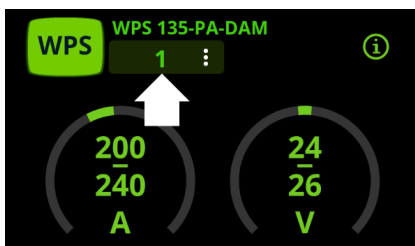

Selecting filler material

1. Click **Select filler material**.

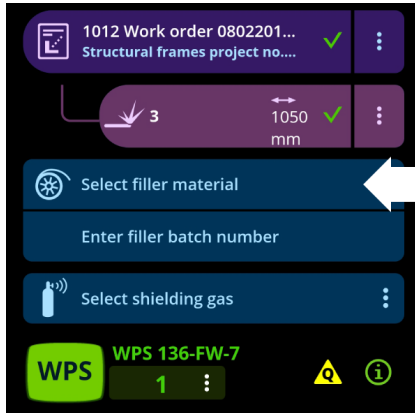

2. Select the filler material used.

 *If a Welding Procedure Specification (WPS) is already selected, and if the WPS includes a recommendation for the filler material, the recommended filler material is shown first on the list.*

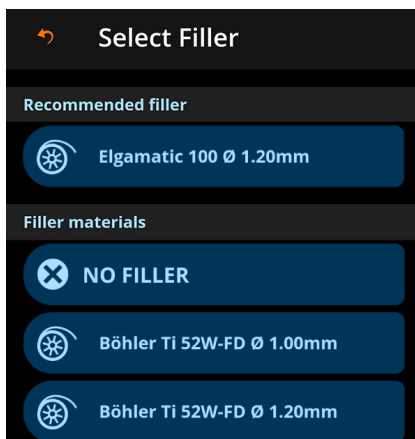

3. Click **Enter filler batch number** and enter the filler material batch number manually or read the barcode with the WeldEye App.

 *Adding the filler material batch information improves traceability later on.*

Selecting shielding gas

1. Click **Select shielding gas**.

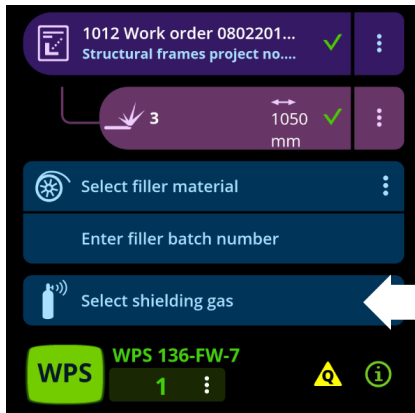

2. Select the shielding gas used.



If a Welding Procedure Specification (WPS) is already selected, and if the WPS includes a recommendation for the shielding gas, the recommended shielding gas is shown first on the list.



DCM and WeldEye App are now ready to record your welding data.

Tip: You can always return to the home view by clicking the **HOME** button at the top.

3.4 During welding

During welding, the WeldEye App displays an informative visualization of the welding parameters and weld progress.



 This view is for informational purposes only. The settings and parameter values shown cannot be changed during welding in the WeldEye App.

3.5 Completing welding tasks with WeldEye App

1. In the home view, select the work order or weld for completion.

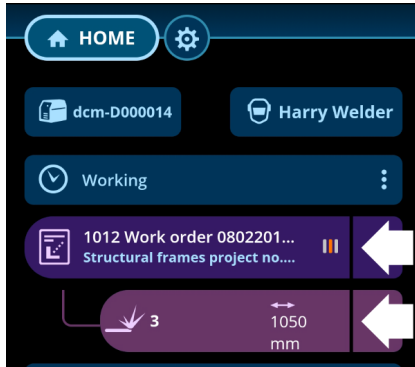

2. At the bottom of the view, select **Complete work order / weld** (depending on the previous selection).

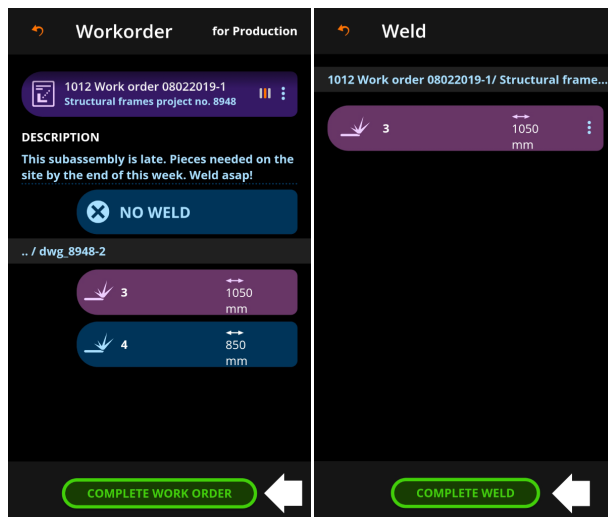

3.6 Synchronizing welding data

Whenever the DCM and the WeldEye App are paired and wirelessly in contact, the welding data on the welding equipment is automatically synchronized. Note that the synchronization with the WeldEye welding management software cloud requires a working internet connection.

-  *Once the welding data has been synchronized, it is automatically erased from the DCM and stored in WeldEye. Otherwise the DCM stores the welding data for two weeks. After that, the data is automatically erased from the device memory.*

3.7 Resetting

The DCM can be reset to factory settings with a long-press of the button on the module.

1. Ensure that the DCM is ready and available: Blue LED blinks infrequently.
2. Press the button on the DCM box for 30 seconds:
 - >> After the first 10 seconds, the leftmost LED turns red.
 - >> After 20 seconds, the leftmost LED turns yellow.
 - >> After 30 seconds, the leftmost LED turns green.



3. When the leftmost LED is lit in green, release the button.

Now the factory settings have been restored and the welding data erased from the memory.

3.8 Disconnecting

You can disconnect the WeldEye App from the DCM and connected welding equipment.

1. In the home view, select the currently connected equipment.



2. Click **Disconnect** to disconnect from the currently connected equipment.

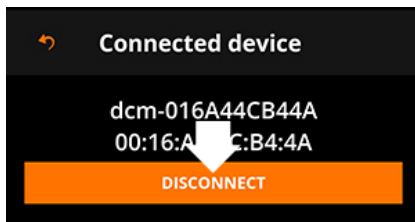

3.9 Updating DCM

To update the Digital Connectivity Module (DCM) firmware, follow these instructions.

Download update

1. Sign in to WeldEye cloud on your computer.
2. Connect an available USB memory stick to the computer.
3. Download the firmware package from WeldEye's *Administration > Machine Fleet > Devices* page.

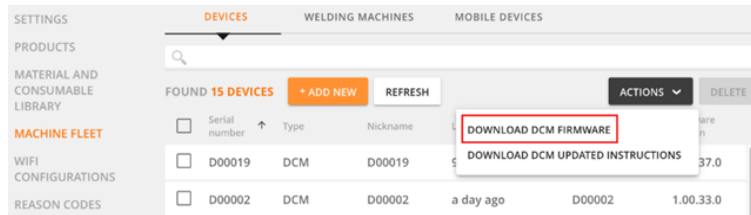

4. Save the firmware package file ('Firmware_SW000138_[version number]_DCM_FIELD.gz') to the root folder of the USB memory stick.

 For example: `D:\Firmware_SW000138_[version number]_DCM_FIELD.gz`. (In the example the USB memory stick is shown as drive D.)

5. Remove the USB memory stick from the computer.

Install update

1. Start the welding machine attached to the DCM and wait approx. 10 seconds until the DCM is on standby.
2. Insert the USB memory stick to the DCM's USB connector.
 - >> A green light starts to blink slowly.
3. Wait until the green light starts to blink rapidly.
4. Remove the USB memory stick from the DCM's USB connector.
 - >> DCM will automatically reboot.
5. Keep the DCM turned on for at least 1 minute. This allows the DCM to set the installed firmware as default.
 - >> The update is now complete.

Verify update

1. Connect the WeldEye App mobile application to the DCM.
2. Open the diagnostics view.
3. Ensure that the DCM version number shown (*Diagnostics view > DCM version*) is the same than the version number in the firmware file name.

4. TECHNICAL DATA

Feature	Description	Value
Operating voltage		12...48 V
Operating temperature range		-20...40°C
Degree of protection	IP class	IP24
External dimensions	LxWxH	30 x 104 x 171
Weight without accessories		0.235 kg
Wireless communication type		2.4 GHz
Wired communication type		CAN, USB, Ethernet
Standards		IEC 60974-1:2012 IEC 60974-10:2014 + A1

5. ORDERING CODES

Product	Ordering code
Digital Connectivity Module (DCM)	6265051