

Operation instructions • english  
Gebrauchsanweisung • deutsch  
Gebruiksaanwijzing • nederlands  
Manuel d'utilisation • français

1922030E  
0546

# KEMPOWELD

## WIRE 200



---

# CONTENTS

<b>1. PREFACE</b> .....	3
1.1. INTRODUCTION .....	3
1.2. PRODUCT INTRODUCTION .....	3
1.3. OPERATION SAFETY .....	3
<b>2. PARTS OF WIRE FEED MECHANISM WIRE 200</b> .....	4
<b>3. KEMPOWELD PANELS</b> .....	5
3.1. OPERATION CONTROL AND CONNECTORS .....	5
3.2. WIRE FEED PANELS .....	6
3.3. INSIDE OF WIRE FEED UNIT .....	6
<b>4. ASSEMBLY OF KEMPOWELD EQUIPMENT</b> .....	7
<b>5. INSTALLATION</b> .....	7
5.1. ACCESSORIES CORRESPONDING TO WIRE DIAMETER .....	7
5.2. INSTALLING MIG WELDING GUN .....	7
5.3. MOUNTING AND LOCKING WIRE REEL .....	8
5.4. AUTOMATIC WIRE FEED TO GUN .....	8
5.5. ADJUSTING PRESSURE .....	8
5.6. ADJUSTING THE TIGHTNESS OF WIRE REEL BRAKE .....	8
5.7. RETURN CURRENT CABLE .....	8
5.8. SHIELD GAS .....	9
5.8.1. INSTALLING GAS BOTTLE .....	9
<b>6. CONTROL PANELS AND ADJUSTMENTS</b> .....	9
6.1. WIRE FEED SPEED POTENTIOMETER .....	9
6.2. BURN BACK TIME .....	9
6.3. KMW TIMER FUNCTIONS .....	10
<b>7. OPERATION DISTURBANCES</b> .....	10
7.1. REGULAR MAINTENANCE OF EQUIPMENT .....	11
<b>8. ORDERING NUMBERS</b> .....	11
<b>9. TECHNICAL DATA</b> .....	11
<b>10. DISPOSAL OF THE MACHINE</b> .....	12
<b>11. TERMS OF GUARANTEE</b> .....	12

---

# 1. PREFACE

## 1.1. INTRODUCTION

Congratulations on having purchased this product. Properly installed Kemppi products should prove to be productive machines requiring maintenance at only regular intervals. This manual is arranged to give you a good understanding of the equipment and its safe operation. It also contains maintenance information and technical specifications. Read this manual from front to back before installing, operating or maintaining the equipment for the first time. For further information on Kemppi products please contact us or your nearest Kemppi distributor.

The specifications and designs presented in this manual are subject to change without prior notice.

In this document, for danger to life or injury the following symbol is used: 

Read the warning texts carefully and follow the instructions. Please also study the Operation safety instructions and respect them when installing, operating and servicing the machine.

## 1.2. PRODUCT INTRODUCTION

Kempoweld WIRE 200 wire feed unit is used with Kempoweld product range, designed for demanding professional use with air-cooled MIG guns. Push-pull guns are used with accessory KMW sync.

You can also equip the Kempoweld power source and the wire feed unit with an air-cooled long distance interconnection cable.

## 1.3. OPERATION SAFETY

Please study these Operation safety instructions and respect them when installing, operating and servicing the machine.

### ***Welding arc and spatters***

Welding arc hurts unprotected eyes. Be careful also with reflecting arc flash. Welding arc and spatter burn unprotected skin. Use safety gloves and protective clothing.

### ***Danger for fire or explosion***

Pay attention to fire safety regulations. Remove flammable or explosive materials from welding place. Always reserve sufficient fire-fighting equipment on welding place. Be prepared for hazards in special welding jobs, eg. for the danger of fire or explosion when welding container type work pieces. Note! Fire can break out from sparks even several hours after the welding work has been finished!

### ***Mains voltage***

Never take welding machine inside a work piece (eg. container or truck). Do not place welding machine on a wet surface. Always check cables before operating the machine. Change defect cables without delay. Defect cables may cause an injury or set out a fire. Connection cable must not be compressed, it must not touch sharp edges or hot work pieces.

### ***Welding power circuit***

Isolate yourself by using proper protective clothing, do not wear wet clothing. Never work on a wet surface or use defect cables. Do not put MIG-gun or welding cables on welding machine or on other electric equipment. Do not press MIG-gun switch, if the gun is not directed towards a work piece.

### ***Welding fumes***

Take care that there is sufficient ventilation during welding. Take special safety precautions when welding metals which contain lead, cadmium, zinc, mercury or beryllium.



**This equipment's electromagnetic compatibility (EMC) is designed for use in an industrial environment. Class A equipment is not intended for use in residential location where the electrical power is provided by the public low-voltage supply system.**

## 2. PARTS OF WIRE FEED MECHANISM WIRE 200

### 2 - roll wire feed mechanism



**Wire guide tubes**

Fe	∅ 0,6...0,8 mm	∅ 1,0 mm white	3134140
Mc	∅ 0,9...1,6 mm	∅ 2,0 mm orange	3133700
Fc			
Ss	∅ 0,8...1,6 mm	∅ 2,5 mm silver	3134290
Al			

brass 4285900 → ∅ 1,8 mm plastic 4102283

**pressure adjustment**

**Syöttöpyörän uran valinta, val av matarhjulspår, valg av matehjul spor, valg af spor i tråd hjul, selection of feed wheel groove, Auswahl der Transportrollennut, selectie van de draaddiameter groef, sélection de la gorge du galet**

**Vetoratas, drivhjul, trekkstannhjul, drivhjul, gearwheel, Aufziehrad, aandrijfrol, galet d'entraînement**  
**∅ 28 mm (0 - 18 m/min) 4265240**  
 Muovi, plast, plast, plastic, plastic, Kunststoff, plastic, plastique  
**∅ 28 mm (0 - 18 m/min) 4287860**  
 Teräs, stål, stål, steel, Stahl, staal, acier

**Vetorataan valintalevyn siirto, flytning av distansbricka, flytting av avstandsskive for matehjul, hvordan flytter man justerskiven, relocation of selection plate, Versetzen der Wahlschalterplatte, verplaatsing van selectie plaat, remise en place de la rondelle de sélection**

4292030

Feed rolls							
Fe	Plain	∅ 0,6/0,8	3133810	∅ 1,0/1,2	3133210	∅ 1,4-1,6	3133820
Ss		∅ 0,8/0,8 (L)	3143180	∅ 1,0/1,0 (L)	3138650	∅ 1,6/1,6 (L)	3141120
Al		white		red		yellow	
	Knurled			∅ 1,2/1,2 (L)	3137390		
Fe				∅ 1,0/1,2	3133940	∅ 1,4-1,6	3133990
Fc				red		∅ 1,6/1,6 (L)	3141130
Mc				∅ 1,2/1,2 (L)	3137380	yellow	
	Trapezoid					∅ 1,4/1,4 (L)	3142220
Fe				∅ 1,2/1,2 (L)	3142210	brown	
Fc				orange		∅ 1,6/1,6 (L)	3142200
Mc						yellow	
Ss							
Al							

(L) = Ball race

W000575

### 3. KEMPOWELD PANELS

#### 3.1. OPERATION CONTROL AND CONNECTORS



- Main switch (pilot lamp)
- Pilot lamp for overheating (power source)
- Voltage selecting switches
- Return current connector
- Return current connector



- Fuse of auxiliary transformer (8 A delayed)
- Control connector of wire feed unit
- Inlet of mains cable
- Welding current connector of wire feed unit (+ pole)

## 3.2. WIRE FEED PANELS

### Front panel

Adjustment of wire feed

### KMW timer

Trigger function mode (continuous/hold)

Welding mode selection (continuous/spot/cycle arc)

Adjustment of welding mode timing (spot or cycle time)

Welding gun connector (EURO)



### Rear panel

Welding current connection  
(Kempoweld or interconnection cable)

Control cable connector  
(Kempoweld or interconnection cable)

Shielding gas connector



## 3.3. INSIDE OF WIRE FEED UNIT

Wire reel locking device

Box door lock

Wire feed mechanism

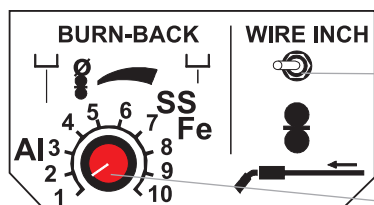
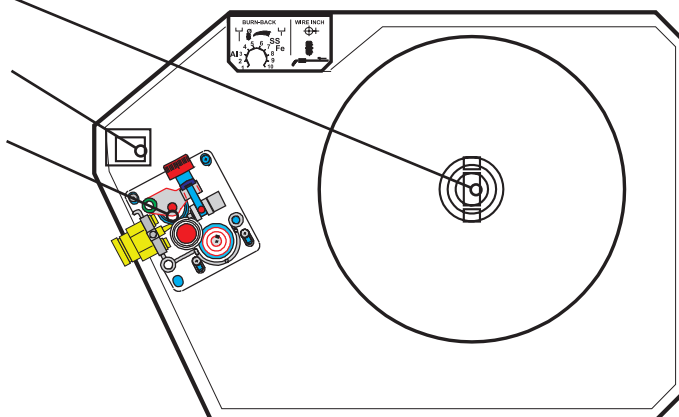

Wire inch switch (wire feed into gun)

Burn back time (according to filler material and wire feed)

## 4. ASSEMBLY OF KEMPOWELD EQUIPMENT

Kempoweld power source: Read chapter “Installation” in the Operation Instructions of the power source.

### Wire feed unit:

1. Mount wire feed unit on the pin on the power source cover.
2. Mount control cable and welding current cable to the connectors to the rear walls and return current cable to the connector on Kempoweld front panel.
3. Welding current polarity: When the connection has been done according to the markings, the gun has positive voltage. In order to change polarity, interchange the welding and return current cable ends connection to the power source.
4. Connect the interconnection cable plugs with the corresponding sockets in units.
5. If the wire feed unit is mounted to boom, it may not have galvanic contact with lift hook and boom.
6. MIG-gun is connected with EURO connector. Use guide tubes and contact tips according to manufacturer’s operation instructions. Accessories which are too tight or otherwise unsuitable for the wire type used, will cause disturbances and excessive stress on accessories.

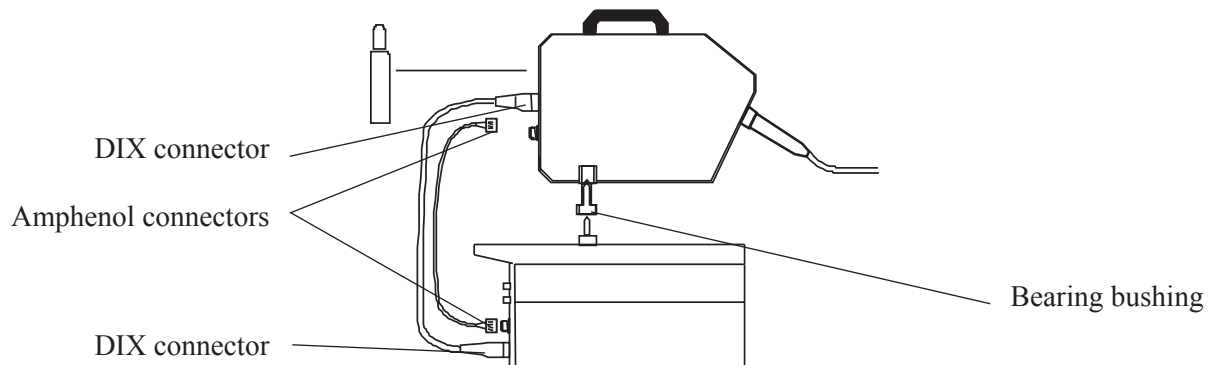

7. Shielding gas hose is mounted to the rear wall of wire feed unit. For installing gas bottle and shielding gas flow adjustment, see the paragraph Shielding gas.

## 5. INSTALLATION

### 5.1. ACCESSORIES CORRESPONDING TO WIRE DIAMETER

The wire feed rolls are available with plain groove, knurled groove and with trapezoidal groove for different purposes.

#### Feed rolls with plain groove:

1. Universal feed roll for welding of all kind of wires.
2. Special feed rolls for heavy duty use.

#### Feed rolls with knurled groove:

Special feed roll for cored wires and steel wires.

#### Feed rolls with trapezoidal groove:

Special feed roll for aluminium wires.

Feed rolls	
colour	filler wire $\varnothing$ mm (inch)
white	0.6 and 0.8 (0.030)
red	0.9/1.0 and 1.2 (0.035, 0.045 and 0.052)
Guide tubes	
colour	filler wire $\varnothing$ mm (inch)
white	0.6 and 0.8 (0.030)
orange	0.9-1.6 (0.035, 0.045 and 0.052)

The wire feed rolls have two grooves for different filler wire diameters. Correct wire groove is chosen by moving selecting washer from one side of feed roll to another. The feed rolls and wire guide tubes of wire feed unit have colour codes in order to make identification easier (see table on page 4). On delivery the Kempoweld WIRE 200 is equipped with red feed rolls with plain groove and with orange wire guide tubes for welding filler wires of 0.9-1.2 mm (0.035", 0.045" and 0.052").

### 5.2. INSTALLING MIG WELDING GUN

To ensure problem-free welding, check in the Operation Instructions of the gun that the wire guide tube and contact tip are in accordance with the manufacturer’s recommendation, and suitable to be used for wire feed diameter and type in question. An overly tight wire guide tube may cause excessive stress on wire feed unit, resulting in disturbances in wire feed.

Screw the snap connector of gun tightly, to avoid voltage losses on connecting surface. A loose connection will heat gun and wire feed unit. After tightening, check that guide tube inside connector is not in contact with feed rolls.

### 5.3. MOUNTING AND LOCKING WIRE REEL

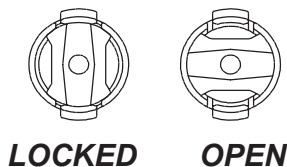

- Release locking nails of wire reel hub by turning locking knob to the position OPEN.
- Put the reel at its place. Note the rotating direction of reel!
- Turn locking knob to the position LOCKED.

**⚠ Check filler wire reel for no protruding parts, which could e.g. chaff against chassis or wire feed unit door. Dragging parts could expose chassis of wire feed unit under voltage.**

### 5.4. AUTOMATIC WIRE FEED TO GUN

Automatic wire feed makes the change of wire reel quicker. The pressure on feed rolls need not be released and filler wire goes automatically to correct wire line.

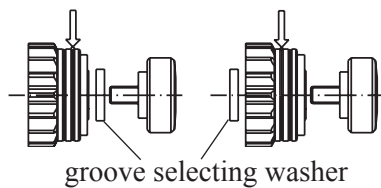

- Make sure that the groove of feed roll matches the diameter of welding wire used. Feed roll groove is selected by moving the groove selection washer. Also the selector plate for changing the feed roll groove has to be moved similarly. (see table on page 4).
- Release the wire end from the reel and cut off the bent length. Be careful that the wire does not spill from the reel to the sides!

- Straighten approximately 20 cm of the wire. Ensure that the wire end has no sharp edges, if necessary file them off. A sharp edge may damage the wire guide tube and contact tip of welding gun.
- Draw a piece of loose wire from wire reel. Feed wire through back liner to feed rolls. Do not release the pressure of the feed rolls!
- Press the gun switch or wire inch switch and feed a piece of wire through feed rolls to the gun. Ensure that wire is in the grooves of both feed rolls!
- Hold down the switch until the wire has come through the contact tip.

Automatic feed may sometimes fail with thin wires (Fe, Ss: 0,6...0,8 mm, Al, Fc: 0,8...1,0 mm). In this case, open feed rolls and feed the wire through manually.

### 5.5. ADJUSTING PRESSURE

Adjust the pressure of feed rolls with control screw, so that the wire is fed into the wire guide tube evenly, and allows a little braking when coming out from the contact tip, without slipping on the feed rolls.

**⚠ Excessive pressure causes flattening of the filler wire and damage to the coating. It also causes friction and undue wear of the feed rolls.**

### 5.6. ADJUSTING THE TIGHTNESS OF WIRE REEL BRAKE

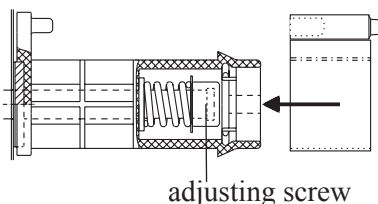

Brake force is adjusted through a hole in the locking device of reel hub by tightening/loosening the adjustment screw with a screwdriver.

Adjust the brake force so big that the wire does not slip from the full reel when the reel stops rotating. The need for brake force is increased with wire feed speed.

Standard accessory: 200 mm wire reel adaptor

**⚠ Make sure that the welding gun is designed for the maximum welding current! Do not use a damaged welding gun!**

### 5.7. RETURN CURRENT CABLE

Fasten earth clamp of return current cable carefully, preferably direct to welding piece. Contact surface of the clamp should always be as large as possible.

Clean the fastening surface from paint and rust!

Use copper cables in your Kempoweld equipment. A too small cross-sectional area might cause overheating of connectors and insulations.



## 5.8. SHIELD GAS



**Handle gas bottle with care. There is a risk for injury if gas bottle or bottle valve is damaged!**

For welding stainless steels, mixed gases are normally used. Check that the gas bottle valve is suitable for the gas. The flow rate is set according to the welding power used in the job. A suitable flow rate is normally 8 - 10 l/min. If the gas flow is not suitable, the welded joint will be sporous. Contact your local Kemppi-dealer for choosing gas and equipment.

### 5.8.1. Installing gas bottle



**Always fasten gas bottle properly in vertical position in a special holder on the wall or on a carriage. Remember to close gas bottle valve after having finished welding.**

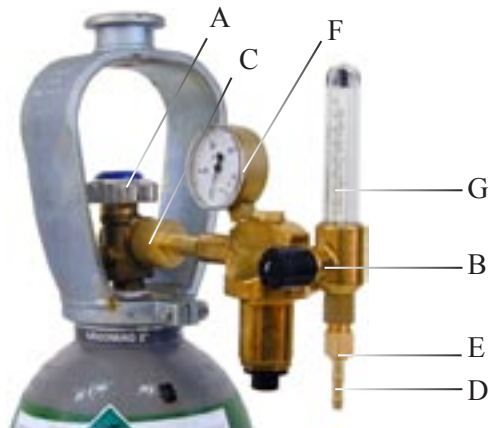

#### **Parts of gas flow regulator**

- A Gas bottle valve
- B Press regulation screw
- C Connecting nut
- D Hose spindle
- E Jacket nut
- F Gas bottle pressure meter
- G Gas hose pressure meter

The following installing instructions are valid for most of the gas flow regulator types:

1. Step aside and open the bottle valve (A) for a while to blow out possible impurities from the bottle valve.
2. Turn the press regulation screw (B) of the regulator until no spring pressure can be felt.
3. Close needle valve, if there is one in the regulator.
4. Install the regulator on bottle valve and tighten connecting nut (C) with a wrench.
5. Install hose spindle (D) and jacket nut (E) into gas hose and tighten with hose clamp.
6. Connect the hose with the regulator and the other end with the wire feed unit. Tighten the jacket nut.
7. Open bottle valve slowly. Gas bottle pressure meter (F) shows the bottle pressure. Note! Do not use the whole contents of the bottle. The bottle should be filled when the bottle pressure is 2 bar.
8. Open needle valve if there is one in the regulator.
9. Turn regulation screw (B) until hose pressure meter (G) shows the required flow (or pressure). When regulating flow amount, the power source should be switched on and the gun switch pressed simultaneously.

Close bottle valve after having finished welding. If the machine will be out of use for a long time, unscrew the pressure regulation screw.

## 6. CONTROL PANELS AND ADJUSTMENTS

### 6.1. WIRE FEED SPEED POTENTIOMETER

The wire feed speed is adjusted with the potentiometer on the front panel, see the chapter Panels. The potentiometer has a memory scale for max. speeds of 18 m/min.

### 6.2. BURN BACK TIME

Different filler materials and shielding gases behave in different ways in the completion of welding. The welding current should be selected for a burn back time suitable for the welding work.

If you try to cease welding with an unsuitable burn back time, the wire will burn in the contact tip, there will be a too large amount of wire at the wire end, or the wire will stick at the stopping point.

Factors influencing the delay:

The required burn back time depends a lot of the wire feed speed. For low wire feed speeds always select a short burn back time.

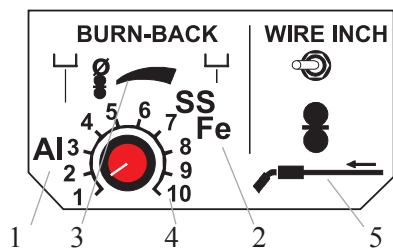

In the instruction labels of filler wires, starting points for adjustment are given. Fine-adjustment should be carried out case-specific.

1. Aluminium melts much quicker than other materials, so the burn back time can be shorter.
2. Steel and especially flux cored wires require a longer burn back time than stainless materials.
3. Thicker filler wires require a longer time. Also, when the wire feed speed increases the burn back time must be extended.
4. Memory scale for potentiometer.
5. Wire inch

### Wire inch

With wire inch, wire feed motor and mechanism can be operated without starting the power source. The filler wire can be driven into the wire feed unit and gun also by pressing the welding gun switch, but then the power source will start and the wire becomes live, which can cause a danger of accidental contacts with surrounding objects!

## 6.3. KMW TIMER FUNCTIONS

### 2 / 4-sequence procedure

 **Welding with the 2-sequence trigger procedure**  **Welding with the 4-sequence trigger procedure**

- |                                                                                                                            |                                                                                                                                                                                                                                            |
|----------------------------------------------------------------------------------------------------------------------------|--------------------------------------------------------------------------------------------------------------------------------------------------------------------------------------------------------------------------------------------|
| <ol style="list-style-type: none"> <li>1. Switch pressed: welding starts</li> <li>2. Switch open: welding stops</li> </ol> | <ol style="list-style-type: none"> <li>1. Switch pressed: shielding gas flows</li> <li>2. Switch open: welding starts</li> <li>3. Switch pressed: welding stops</li> <li>4. Switch open: gas flow stops after the post gas time</li> </ol> |
|----------------------------------------------------------------------------------------------------------------------------|--------------------------------------------------------------------------------------------------------------------------------------------------------------------------------------------------------------------------------------------|

### Spot, cycle arc and continuous welding (only in the 2-sequence procedure)

#### Spot welding ●

1. Set the spot time with potentiometer.
2. Press the gun switch: welding starts
3. Welding ends automatically after the preset time.

#### Cycle arc welding — — —

1. Set the welding cycle time with the potentiometer. The pause time is adjusted automatically.
2. Press the gun switch: cycle welding is continued as long as the switch remains pressed.

## 7. OPERATION DISTURBANCES

The use and working environment of the equipment should be taken into consideration when planning the maintenance of the wire feed unit. Careful use and preventive maintenance will help to ensure problem-free operation.

The following maintenance operations should be carried out at least every six months:

### Check:

- The wear of feed roll grooves. Excessive wear of grooves will cause problems in wire feed.
- The wear of wire guide tubes in wire feed unit. Worn-out feed rolls and wire guide tubes should be replaced.
- The wire guide tube in the gun should be set as close to the feed rolls as possible, but not in contact with them. The wire must be in a straight line from the end of the tube to the feed roll groove.
- Reel brake adjustment
- Electric connections
- \* Oxidised couplings must be cleaned.
- \* Loose couplings must be tightened.

Clean dust and dirt from the equipment.

In case of problems contact your Kemppi dealer.

 **When using compressed air, always use proper eye protection.**

## 7.1. REGULAR MAINTENANCE OF EQUIPMENT

Kemppli service workshops make special service contracts with customers about regular maintenance.

### The major points of the maintenance are:

- Cleaning the equipment
- Checking and maintenance of the welding tools
- Checking connectors, switches and potentiometers
- Checking electric connections
- Inspecting metering units
- Checking mains cable and plug
- Replacing damaged parts or parts in bad condition
- Maintenance testing. Operation and performance of the equipment are checked, and the values are adjusted when necessary with the test equipment.

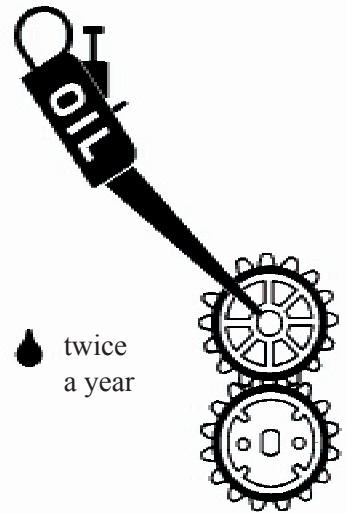

## 8. ORDERING NUMBERS

### Wire feed unit

Kempoweld WIRE 200 62172001

### Accessory

P500 transport unit (feeder) 6185265  
Hub for wheel reel 4289880

### Power source

Kempoweld 2501 240 V 6211255

### MIG gun

KMG 25 3 m 6252123

### Interconnection cable

KW 35-5-GH 5 m 6260355

### Return current cable

35 mm<sup>2</sup> 5 m (part 7) 6184311

## 9. TECHNICAL DATA

The products meet the conformity requirements of CE-marking.

WIRE 200		
Working voltage		30 VAC
Connection power		150 VA
Loading capacity (nominal values)	40 % ED 60 % ED 100 % ED	400 A - - - 260 A
Operation principle		2-roll drive
Diameter of wheel roll		32 mm
Wire feed speed		0...18 m / min
Filler wires	∅ Fe, Ss ∅ Cored wire ∅ Al	0,6...1,2 mm 0,8...1,6 mm 1,0...1,6 mm
Wire reel	max. weight max. size	20 kg ∅ 300 mm
Gun connector		Euro
Operation temperature range		-20...+40 °C
Storage temperature range		-40...+60 °C
Degree of protection		IP 23C
Dimensions	length width height	570 mm 210 mm 440 mm
Weight		12 kg

---

## 10. DISPOSAL OF THE MACHINE



Do not dispose of electrical equipment together with normal waste!

In observance of European Directive 2002/96/EC on Waste Electrical and Electronic Equipment and its implementation in accordance with national law, electrical equipment that has reached the end of its life must be collected separately and returned to an environmentally compatible recycling facility. As the owner of the equipment, you should get information on approved collection systems from our local representative.

By applying this European Directive you will improve the environment and human health!

## 11. TERMS OF GUARANTEE

Kemppi Oy provides a guarantee for products manufactured and sold by them if defects in manufacture and materials occur. Guarantee repairs must be carried out only by an Authorised Kemppi Service Agent. Packing, freight and insurance costs to be paid by orderer. The guarantee is effected on the date of purchase. Verbal promises which do not comply with the terms of guarantee are not binding on guarantor.

### ***Limitations on guarantee***

The following conditions are not covered under the terms of guarantee: defects due to natural wear and tear, non-compliance with operating and maintenance instructions, connection to incorrect or faulty supply voltage (including voltage surges outside equipment spec.), incorrect gas pressure, overloading, transport or storage damage, fire or damage due to natural causes i.e. lightning or flooding.

This guarantee does not cover direct or indirect travelling costs, daily allowances or accommodation. Note: Under the terms of guarantee, welding torches and their consumables, feeder drive rolls and feeder guide tubes are not covered. Direct or indirect damage due to a defective product is not covered under the guarantee. The guarantee is void if changes are made to the product without approval of the manufacturer, or if repairs are carried out using non-approved spare parts.

The guarantee is also void if repairs are carried out by non-authorised agents.

### ***Undertaking guarantee repairs***

Guarantee defects must be informed to Kemppi or authorised Kemppi Service Agents within the guarantee period. Before any guarantee work is undertaken, the customer must provide proof of guarantee or proof of purchase, and serial number of the equipment in order to validate the guarantee. The parts replaced under the terms of guarantee remain the property of Kemppi.

Following the guarantee repair, the guarantee of the machine or equipment, repaired or replaced, will be continued to the end of the original guarantee period.

KEMPPi OY  
PL 13  
FIN – 15801 LAHTI  
FINLAND  
Tel (03) 899 11  
Telefax (03) 899 428  
www.kemppi.com

KEMPPiKONEET OY  
PL 13  
FIN – 15801 LAHTI  
FINLAND  
Tel (03) 899 11  
Telefax (03) 7348 398  
e-mail: myynti.fi@kemppi.com

KEMPPi SVERIGE AB  
Box 717  
S – 194 27 UPPLANDS VÄSBY  
SVERIGE  
Tel (08) 590 783 00  
Telefax (08) 590 823 94  
e-mail: sales.se@kemppi.com

KEMPPi NORGE A/S  
Postboks 2151, Postterminalen  
N – 3103 TØNSBERG  
NORGE  
Tel 33 34 60 00  
Telefax 33 34 60 10  
e-mail: sales.no@kemppi.com

KEMPPi DANMARK A/S  
Literbuen 11  
DK – 2740 SKOVLUNDE  
DANMARK  
Tel 44 941 677  
Telefax 44 941 536  
e-mail:sales.dk@kemppi.com

KEMPPi BENELUX B.V.  
Postbus 5603  
NL – 4801 EA BREDA  
NEDERLAND  
Tel +31 (0)76-5717750  
Telefax +31 (0)76-5716345  
e-mail: sales.nl@kemppi.com

KEMPPi (UK) Ltd  
Martti Kemppi Building  
Fraser Road  
Priory Business Park  
BEDFORD, MK443WH  
ENGLAND  
Tel 0845 6444201  
Fax 0845 6444202  
e-mail: sales.uk@kemppi.com

KEMPPi FRANCE S.A.  
65 Avenue de la Couronne des Prés  
78681 EPONE CEDEX  
FRANCE  
Tel (01) 30 90 04 40  
Telefax (01) 30 90 04 45  
e-mail: sales.fr@kemppi.com

KEMPPi GmbH  
Otto – Hahn – Straße 14  
D – 35510 BUTZBACH  
DEUTSCHLAND  
Tel (06033) 88 020  
Telefax (06033) 72 528  
e-mail:sales.de@kemppi.com

KEMPPi SP. z o.o.  
Ul. Piłsudskiego 2  
05-091 ZĄBKI  
Poland  
Tel +48 22 781 6162  
Telefax +48 22 781 6505  
e-mail: info.pl@kemppi.com

KEMPPi WELDING  
MACHINES AUSTRALIA PTY LTD  
P.O. Box 404 (2/58 Lancaster Street)  
Ingleburn NSW 2565, Australia  
Tel. +61-2-9605 9500  
Telefax +61-2-9605 5999  
e-mail: info.au@kemppi.com