

TTK | 130, 130F, 160, 160S 220, 220S, 300W, 350W, 250WS



Operating manual • English *EN*

Käyttöohje • Suomi *FI*

Bruksanvisning • Svenska *SV*

Bruksanvisning • Norsk *NO*

Brugsanvisning • Dansk *DA*

Gebrauchsanweisung • Deutsch *DE*

Gebruiksaanwijzing • Nederlands *NL*

Manuel d'utilisation • Français *FR*

Инструкции по эксплуатации • По-русски *RU*

OPERATING MANUAL

English

CONTENTS

1. PREFACE	3
1.1 General.....	3
1.2 Product introduction.....	3
1.2.1 Selection table for consumable parts TTK 130, TTK 130F, TTK 160S, TTK 300W, TTK 250WS.....	4
1.2.2 Selection table for consumable parts TTK 160, TTK 220, TTK 220S, TTK 350W.....	5
1.3 Operation safety.....	6
2. INSTALLATION	6
2.1 Connecting TTK-torch.....	6
2.2 Switch and regulator operations.....	6
2.3 Adjustment of torch body and grips.....	7
3. MAINTENANCE	7
4. OPERATION DISTURBANCES	8
4.1 The most usual operation disturbances are as follows.....	8
5. ORDERING NUMBERS	8
6. TECHNICAL DATA	9

1. PREFACE

1.1 GENERAL

Congratulations on having purchased this product. Used correctly, Kemppi products can significantly increase the productivity of your welding, and provide years of economical service.

This operating manual contains important information on the use, maintenance and safety of your Kemppi product. The technical specifications of the equipment can be found at the end of the manual.

Please read the manual carefully before using the equipment for the first time. For your own safety and that of your working environment, pay particular attention to the safety instructions in the manual.

For more information on Kemppi products, contact Kemppi Oy, consult an authorised Kemppi dealer, or visit the Kemppi web site at www.kemppi.com.

The specifications presented in this manual are subject to change without prior notice.

Important notes

Items in the manual that require particular attention in order to minimise damage and personal harm are indicated with the '**NOTE!**' notation. Read these sections carefully and follow their instructions.

Disclaimer







While every effort has been made to ensure that the information contained in this guide is accurate and complete, no liability can be accepted for any errors or omissions. Kemppi reserves the right to change the specification of the product described at any time without prior notice. Do not copy, record, reproduce or transmit the contents of this guide without prior permission from Kemppi.

1.2 PRODUCT INTRODUCTION





TTK 130, TTK 130F, TTK 160, TTK 160S, TTK 220, TTK 220S, TTK 300W, TTK 350W and TTK 250WS are TIG welding torches designed for demanding use. They are suitable to be used e.g. with the Mastertig and Mastertig AC/DC welding machines.

1.2.1 Selection table for consumable parts TTK 130, TTK 130F, TTK 160S, TTK 300W, TTK 250WS

Normal gas nozzle equipment

Welding current										
									9878013	
DC (A)	AC (A)	_____					Size			
		ø mm (in)								
			WC20	9873531				3	9878018	
5 – 80	5 – 50	1,0 (.040)	WZ8	9873520	7990635	7990640	7990660	4	7990760	9878019
								5	7990761	9878020
			WC20	9873532				4	7990760	9878019
70 – 150	30 – 100	1,6 (1/16)	WZ8	9873521	7990636	7990641	7990661	5	7990761	9878020
								6	7990762	9878021
			WC20	9873533						
130 – 250	80 – 150	2,4 (3/32)	WZ8	9873522	7990637	7990642	7990662	6	7990762	9878021
								7	7990763	-





Gas lens equipment

Welding current										
									9878013	
DC (A)	AC (A)	_____					Size			
		ø mm (in)								
			WC20	9873531						
5 – 80	5 – 50	1,0 (.040)	WZ8	9873520	7990635	7990640	7990700	4	7990779	
								5	7990780	
			WC20	9873532				4	7990779	
70 – 150	30 – 100	1,6 (1/16)	WZ8	9873521	7990636	7990641	7990701	5	7990780	
								6	7990781	
			WC20	9873533						
130 – 250	80 – 150	2,4 (3/32)	WZ8	9873522	7990637	7990642	7990702	6	7990781	
								7	7990782	





Data in table are given only as a guide.

1.2.2 Selection table for consumable parts TTK 160, TTK 220, TTK 220S, TTK 350W

Normal gas nozzle equipment

Welding current								
								9580266
DC (A)	AC (A)	Ø mm (in)				Size		
			WC20	9873531				
5 – 80	5 – 50	1,0 (.040)	WZ8	9873520	9876866	7990680	4	7990766
							5	7990770
			WC20	9873532			4	7990766
70 – 150	30 – 100	1,6 (1/16)	WZ8	9873521	9876867	7990681	5	7990770
							6	7990771
			WC20	9873533				
130 – 250	80 – 150	2,4 (3/32)	WZ8	9873522	9876868	7990682	6	7990771
							7	7990772
			WC20	9873534			7	7990772
220 – 350	120 – 210	3,2 (1/8)	WZ8	9873523	9876869	7990683	8	7990773
							10	7990775
			WC20	9873535			8	7990773
330 – 500	180 – 280	4,0 (5/32)	WZ8	9873524	9876870	7990684	10	7990775
			W	9873505			12	7990776

Gas lens equipment

Welding current									
								9876860 + 9580266	
DC (A)	AC (A)	Ø mm (in)				Size			
			WC20	9873531					
5 – 80	5 – 50	1,0 (.040)	WZ8	9873520	9876866	7990710	5	7990783	
			WC20	9873532					
70 – 150	30 – 100	1,6 (1/16)	WZ8	9873521	9876867	7990711	5	7990783	
							6	7990784	
			WC20	9873533					
130 – 250	80 – 150	2,4 (3/32)	WZ8	9873522	9876868	7990712	6	7990784	
							7	7990785	
			WC20	9873534			7	7990785	
220 – 350	120 – 210	3,2 (1/8)	WZ8	9873523	9876869	7990713	8	7990786	
							11	7990787	
			WC20	9873535					
330 – 500	180 – 280	4,0 (5/32)	WZ8	9873524	9876870	7990714	8	7990786	
			W	9873505			11	7990787	

Data in table are given only as a guide.

1.3 OPERATION SAFETY

Please study these Operation safety instructions and respect them when installing, operating and servicing the machine.

Welding arc and spatters

Welding arc hurts unprotected eyes. Be careful also with reflecting arc flash. Welding arc and spatter burn unprotected skin. Use safety gloves and protective clothing.

Danger for fire or explosion

Pay attention to fire safety regulations. Remove flammable or explosive materials from welding place. Always reserve sufficient fire-fighting equipment on welding place. Be prepared for hazards in special welding jobs, eg. for the danger of fire or explosion when welding container type work pieces. Note! Fire can break out from sparks even several hours after the welding work has been finished!

Mains voltage

Never take welding machine inside a work piece (eg. container or truck). Do not place welding machine on a wet surface. Always check cables before operating the machine. Change defected cables without delay. Defected cables may cause an injury or set out a fire. Connection cable must not be compressed, it must not touch sharp edges or hot work pieces.

Welding power circuit

Isolate yourself by using proper protective clothing, do not wear wet clothing. Never work on a wet surface or use defected cables. Do not put TIG-torch or welding cables on welding machine or on other electric equipment. Do not press TIG-torch switch, if the gun is not directed towards a work piece.

Welding fumes

Take care that there is sufficient ventilation during welding. Take special safety precautions when welding metals which contain lead, cadmium, zinc, mercury or beryllium.

2. INSTALLATION

2.1 CONNECTING TTK-TORCH

Connect torch (and extension parts) according to welding machine's operation instructions. Tighten adaptors of torch carefully in order to avoid heating of adaptors, contact disturbances, mechanical damage and water or gas leakage.

NOTE! Check by connection of liquid hoses that there are no dirt, metal powder or other wastes. Wastes may cause blocking in liquid circulation, throughburning of torch or stopping or breaking of pump.

Connect liquid hoses of torch according to operation instruction of the cooling liquid circulation unit. (They are fastened to pipe chassis.) Fix liquid hoses (torch – cooling liquid circulation unit) in such a way that those having red code always are connected to corresponding red counter connectors and the blue ones respectively to blue counter connectors.

NOTE! If connections cross, cooling liquid is circulating in wrong direction in torch, and torch handle and neck body might be considerably heated.

2.2 SWITCH AND REGULATOR OPERATIONS

The TTK torches are equipped with ON/OFF switch. Operation of switch in 2-functions, 4-functions and Minilog positions is described in operation instructions of the welding machine.

2.3 ADJUSTMENT OF TORCH BODY AND GRIPS

You can draw the torch neck outwards from inside the handle in approx. 30 mm length in order to grow reach or to minimize heat radiation to welder's hand. You can also twist the torch body 360° in regard of the handle. Twisting of neck makes the length adjustment easier. Before starting to weld make sure that the parts being exposed to voltage at the back end of the neck body are not visible.

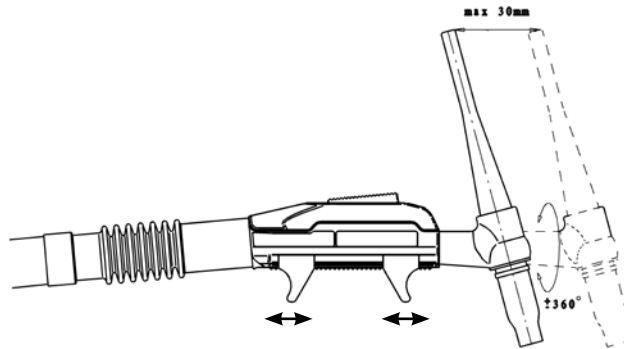

You can without tools move or twist grips on the lower surface of the handle into such position you like that you can get a steady hold on the torch. You can also easily remove one or both of the grips through the front end of the handle.

3. MAINTENANCE

The amount of use and working environment should be taken into consideration when planning the frequency of maintenance of TIG torches. Careful use and preventive maintenance will help to ensure trouble-free operation and long lifetime for the gun.

Due to high temperatures and wear the welding end of TIG torch requires most maintenance, but also condition of other parts should be checked regularly.

Welding end

Check that...

- All insulations of welding end are undamaged and at their place.
- Gas nozzle is undamaged and suitable for work.
- Flow of shielding gas is free and even.
- Electrode is undamaged. Use electrode size and tip sharpening angle which is suitable for welding case. Make sharpening grinding lengthwise of electrode.
- Fastening parts of electrode are undamaged and electrode is fastened tightly at its place.

Torch cable

Check that...

- Insulations of handle and torch cable are undamaged.
- There are no sharp bends in torch cable.

Replace damaged parts immediately by new ones.

NOTE! Frequent bending of neck body of torch may cause damage of gas or liquid channels. Length adjustment of neck body doesn't work on bent neck.

4. OPERATION DISTURBANCES

4.1 THE MOST USUAL OPERATION DISTURBANCES ARE AS FOLLOWS

Arc is not ignited:

- Cable is loose or there is a bad connection.
- Electrode of torch is highly oxidized (grey). Sharpen again lengthwise. Check that post gas time is long enough. Check ignition by using pre-gas e.g. by 4-function operation of torch.
- There are impurities in shielding gas (moisture, air).
- Protective hose or another insulation of torch is broken and ignition spark is "escaping" from elsewhere than from electrode of torch.
- Torch is wet.
- At low current is used too big or blunt electrode.

Gas shielding is bad (weld pool "is boiling", electrode will be oxidized)

- There are impurities in shielding gas (moisture, air).
- There are impurities in base material (rust, base coat, grease).
- On gas nozzle or housing of tightening bushing has stuck "spatter".
- Net of gas lens is damaged.
- There is too much draught at welding place.
- Note! With gas lens equipment you get a more balanced gas flow than with normal gas nozzle equipment.

5. ORDERING NUMBERS

	4 m	8 m	16 m
TTK 130	627063004	627063008	627063016
TTK 130F	627063104	627063108	627063116
TTK 160	627066004	627066008	627066016
TTK 160S	627066204	627066208	627066216
TTK 220	627072004	627072008	627072016
TTK 220S	627072304	627072308	627072316
TTK 300W	627080504	627080508	627080516
TTK 350W	627085504	627085508	627085516
TTK 250WS	627075704	627075708	627075716

6. TECHNICAL DATA

	Loading capacity DC-		Electrode sizes to be used	Voltage class	Cooling	Connection to TIG-unit			
	40% ED	100% ED				Gas/ current	Water/ current	Water	Gas
TTK 130	130A	-	ø 1,0 – 2,4	L	Air	R¼	-	-	-
TTK 130F	130A	-	ø 1,0 – 2,4	L	Air	R¼	-	-	-
TTK 160	160A	-	ø 1,0 – 2,4	L	Air	R¼	-	-	-
TTK 160S	160A	-	ø 1,0 – 2,4	L	Air	R¼	-	-	-
TTK 220	220A	-	ø 1,0 – 3,2	L	Air	R¼	-	-	-
TTK 220S	220A	-	ø 1,0 – 3,2	L	Air	R¼	-	-	-
TTK 300W	300A	200A	ø 1,0 – 2,4	L	Liquid - min. 1 l/min In inlet: - max. 50 °C - min. 1 bar - max. 5 bar	-	R3/8	R3/8	R1/4
TTK 350W	350A	250A	ø 1,0 – 4,0	L	Liquid - min. 1 l/min In inlet: - max. 50 °C - min. 1 bar - max. 5 bar	-	R3/8	R3/8	R1/4
TTK 250WS	250A	200A	ø 1,0 – 4,0	L	Liquid - min. 1 l/min In inlet: - max. 50 °C - min. 1 bar - max. 5 bar	-	R3/8	R3/8	R1/4

Make sure that the torch being in your use is designed for max. welding current needed by you.

The torch meets the construction and safety requirements according to norm IEC / EN 60974-7.

KEMPPI OY

Hennalankatu 39
PL 13
FIN-15801 LAHTI
FINLAND
Tel +358 3 899 11
Telefax +358 3 899 428
export@kemppi.com
www.kemppi.com

Kotimaan myynti:

Tel +358 3 899 11
Telefax +358 3 734 8398
myynti.fi@kemppi.com

KEMPPI SVERIGE AB

Box 717
S-194 27 UPPLANDS VÄSBY
SVERIGE
Tel +46 8 590 783 00
Telefax +46 8 590 823 94
sales.se@kemppi.com

KEMPPI NORGE A/S

Postboks 2151, Postterminalen
N-3103 TØNSBERG
NORGE
Tel +47 33 346000
Telefax +47 33 346010
sales.no@kemppi.com

KEMPPI DANMARK A/S

Literbuen 11
DK-2740 SKOVLUNDE
DANMARK
Tel +45 4494 1677
Telefax +45 4494 1536
sales.dk@kemppi.com

KEMPPI BENELUX B.V.

Postbus 5603
NL-4801 EA BREDA
NEDERLAND
Tel +31 765717750
Telefax +31 765716345
sales.nl@kemppi.com

KEMPPI (UK) Ltd

Martti Kemppi Building
Fraser Road
Priory Business Park
BEDFORD, MK44 3WH
UNITED KINGDOM
Tel +44 (0)845 6444201
Telefax +44 (0)845 6444202
sales.uk@kemppi.com

KEMPPI FRANCE S.A.S.

65 Avenue de la Couronne des Prés
78681 EPONE CEDEX
FRANCE
Tel +33 1 30 90 04 40
Telefax +33 1 30 90 04 45
sales.fr@kemppi.com

KEMPPI GmbH

Otto-Hahn-Straße 14
D-35510 BUTZBACH
DEUTSCHLAND
Tel +49 6033 88 020
Telefax +49 6033 72 528
sales.de@kemppi.com

KEMPPI SPÓŁKA Z O.O.

Ul. Borzymowska 32
03-565 WARSZAWA
POLAND
Tel +48 22 7816162
Telefax +48 22 7816505
info.pl@kemppi.com

KEMPPI AUSTRALIA PTY LTD.

13 Cullen Place
P.O. Box 5256, Greystanes NSW 2145
SMITHFIELD NSW 2164
AUSTRALIA
Tel. +61 2 9605 9500
Telefax +61 2 9605 5999
info.au@kemppi.com

ООО КЕМППИ

Polkovaya str. 1, Building 6
127018 MOSCOW
RUSSIA
Tel +7 495 739 4304
Telefax +7 495 739 4305
info.ru@kemppi.com

ООО КЕМППИ

ул. Полковная 1, строение 6
127018 Москва
Tel +7 495 739 4304
Telefax +7 495 739 4305
info.ru@kemppi.com

KEMPPI, TRADING (BEIJING) COMPANY, LIMITED

Room 420, 3 Zone, Building B,
No.12 Hongda North Street,
Beijing Economic Development Zone,
100176 Beijing
CHINA
Tel +86-10-6787 6064
+86-10-6787 1282
Telefax +86-10-6787 5259
sales.cn@kemppi.com
肯倍贸易 (北京) 有限公司
中国北京经济技术开发区宏达北路12号
创新大厦B座三区420室 (100176)
电话 : +86-10-6787 6064
+86-10-6787 1282
传真 : +86-10-6787 5259
sales.cn@kemppi.com

KEMPPI INDIA PVT LTD

LAKSHMI TOWERS
New No. 2/770,
First Main Road,
KAZURA Gardens,
Neelangarai,
CHENNAI - 600 041
TAMIL NADU
Tel +91-44-4567 1200
Telefax +91-44-4567 1234
sales.india@kemppi.com